

GRUNDIG

Washing Machine

User Manual



GWP810616MW

2820529962/ EN/ / 28/01/2022 11:02

CE

1	Safety Instructions	4	6.2	Symbols on the Display.....	21
1.1	Intended Use.....	4	6.3	Programme and Consumption Table	22
1.2	Safety of Children, Vulnerable Per- sons and Pets	4	6.4	Programme Selection	23
1.3	Electrical Safety	5	6.5	Programmes.....	23
1.4	Handling Safety	6	6.6	Temperature Selection.....	27
1.5	Installation Safety.....	6	6.7	Spin Speed Selection.....	27
1.6	Operational Safety	7	6.8	Auxiliary Function Selection.....	28
1.7	Maintenance and Cleaning Safety.	9	6.8.1	Auxiliary Functions.....	28
2	Important Instructions for Envir- onment	9	6.8.2	Functions/Programmes Selec- ted by Pressing the Function Keys for 3 Seconds	29
2.1	Compliance with WEEE Directive..	9	6.9	End Time	31
2.2	Package Information.....	10	6.10	Starting the Programme.....	32
3	Technical Specifications	11	6.11	Loading Door Lock	32
4	Installation	12	6.12	Changing the Selections After Pro- gramme has Started	33
4.1	Appropriate Installation Location...	12	6.13	Cancelling the Programme.....	33
4.2	Installation of Bottom Panel Cover	12	6.14	End of Programme.....	34
4.3	Removing Transportation Safety Bolts.....	13	6.15	HomeWhiz Feature and Remote Control Function	34
4.4	Connecting to Water Supply.....	13	6.15.1	HomeWhiz Setup	34
4.5	Connecting the Drain Hose to the Drain.....	13	6.15.2	Setting up a Washing Machine Connected to Someone Else's Account	36
4.6	Adjusting the Stands	14	6.15.3	Deleting the HomeWhiz Account Match.....	36
4.7	Electrical Connection	14	6.15.4	Remote Control Function and Using It.....	36
4.8	Start Up.....	14	6.15.5	Troubleshooting	37
5	Preliminary Preparation.....	15	6.16	Drum Illumination	37
5.1	Sorting the Laundry	15	7	Maintenance and Cleaning.....	37
5.2	Preparing Laundry for Washing....	15	7.1	Cleaning the Detergent Drawer	38
5.3	Tips for Energy and Water Saving.	15	7.2	Cleaning the Loading Door and the Drum.....	39
5.4	Loading the Laundry	15	7.3	Cleaning the Body and Control Panel	39
5.5	Correct Load Capacity.....	16	7.4	Cleaning the Water Intake Filters....	39
5.6	Using Detergent and Softener.....	16	7.5	Draining Remaining Water and Cleaning the Pump Filter	40
5.6.1	Automatic Dosing	17	8	Troubleshooting	41
5.6.2	Dosage Selections, Cancellation or Use of Powder Detergent.....	18			
5.6.3	Detergent and/or Softener Run- ning Out.....	18			
5.6.4	Filling Detergent or Softener into the Wrong Compartment	19			
5.7	Tips for Efficient Washing.....	19			
5.8	Displayed Programme Duration	19			
6	Operating the Product.....	20			
6.1	Control Panel.....	20			

Please read this user manual first!

Dear Customer,







Thank you for choosing Grundig product. We hope that you get the best results from your product which has been manufactured with high quality and state-of-the-art technology. Therefore, please read this entire user manual and all other accompanying documents carefully before using the product.

Follow all warnings and information in the user manual. Thus, you protect yourself and your product against possible dangers.

Keep the user manual. If you hand over the product to someone else, provide the user manual as well. Warranty terms, usage and troubleshooting methods of your product are in user guide.

Symbols and Definitions

The following symbols are used in the user guide:

	Danger that could result in death or injury.
	Important information or useful hints about usage.
	Read the user manual.
	Recyclable materials.
 	Hot surface warning.
WARNING	Danger that may result in property damage to the product or its environment.



1 Safety Instructions

This section includes the safety instructions necessary to prevent the risk of personal injury or material damage.

Our company shall not be held responsible for damages that may occur if these instructions are not observed.

- Installation and repair operations shall always be performed by Authorised Service.
- Use original spare parts and accessories only.
- Do not repair or replace any component of the product unless it is clearly specified in the operation manual.
- Do not modify the product.



1.1 Intended Use

- This product has been designed for domestic use. It is not for commercial purposes or it should not be used out of its intended use.
- The product must only be used for washing and rinsing of laundry that are marked accordingly
- This appliance is intended to be used in household and similar applications. For example;

- Personnel kitchens of stores, offices and other work environments;
- Ranches,
- By customers of hotels, motels and other accommodation facilities,
- Bed and breakfasts, hostel-like environments,
- Common areas of apartment blocks or laundries.



1.2 Safety of Children, Vulnerable Persons and Pets

- This product may be used by children aged 8 years and older and persons with underdeveloped physical, sensory or mental capabilities or lack of experience and knowledge if they have been given supervision or instruction concerning use of the appliance in a the product safe way and the hazards involved.
- Children under the age of 3 should be kept away unless continuously supervised.
- Electrical products are dangerous for children and pets. Children or pets should not play

with, climb on top or inside the product. Check inside the product before use.

- Use child lock to prevent children from intervening with the product.
- Do not forget to close the loading door when leaving the room where the product is located. Children and pets may get locked inside and drown.
- Children should not perform cleaning and user maintenance works without an adult's supervision.
- Keep the packaging materials away from children. Risk of injury and suffocation.
- Keep all detergents and additives used for the product away from children's reach.
- Cut the power cable and break and deactivate the locking mechanism of the loading door before disposing of the product for children's safety.

1.3 Electrical Safety

- Product should be unplugged during installation, maintenance, cleaning and repair procedures.

- If the power cable is damaged, it must be replaced by the authorised service in order to avoid possible risks.
- Do not tuck the power cable under and behind the product. Do not place heavy objects on the power cable. Do not over bend, crush and touch the power cable to sources of heat.
- Do not use an extension cord, multi-plug or adaptor to operate your product.
- The plug shall be easily accessible. If this is not possible, a mechanism that meets the electrical legislation and that disconnects all terminals from the mains (fuse, switch, main switch, etc.) shall be available on the electrical installation.
- Do not touch the plug with wet hands.
- When unplugging the appliance, don't hold the power cord, but the plug.
- Make sure the plug is not wet, dirty or dusty.

1.4 Handling Safety

- Unplug the product before moving, remove the water outlet and water main connections. Drain any water left inside the product.
- The product is heavy, do not move alone. Do not hold extruding parts such as the laundry loading door to lift and move the product. The upper tray should be tightly fixed for moving.
- Your product is heavy; it should be carried carefully by two people if a staircase is involved. It may cause injuries if your product falls on you. Do not hit and drop the product while carrying.
- Carry the product in an upright position.
- Make sure that the hoses as well as the power cable are not folded, pinched or crushed after the product is fitted into its place after installation or cleaning procedures.

1.5 Installation Safety

- Check the information on the manual and installation instructions to prepare the product for installation and

make sure the electrical mains, clean water mains and water outlet are suitable. If not, call a qualified electrician and plumber to have them make the necessary arrangements. These operations are the responsibility of the customer.

- Check for any damages before installing the product. Do not go ahead with the installation if the product is damaged.
- Injuries may occur if hands are put into uncovered slots. Close the holes of the transportation safety bolts with plastic plugs.
- Do not install or leave the product at locations where it may be exposed to external environment conditions.
- Do not install the product at locations where the temperature drops below 0 °C.
- Do not place the product on a carpet or similar surface. It would create fire hazard since it cannot receive air from underneath.
- Place the product on a level and hard surface and balance with the adjustable legs.

- Connect the product to a grounding plug protected by a fuse suitable to the current values on the type label. Make sure the grounding is carried out by an expert electrician. Do not use the product without suitable grounding to local/national regulations.
- Plug the product in a socket with voltage and frequency values suitable to those indicated on the type label.
- Do not plug the product to loose, broken, dirty, greasy sockets or sockets that has come out their seats or sockets with a risk of water contact.
- Use the new hose set provided with the product. Do not re-use old hose sets. Do not make additions to the hoses.
- Connect the water inlet hose directly to the water tap. The pressure from the tap should be minimum 0.1 MPa (1 bar) and maximum 1MPa (10 bars). 10 to 80 litres of water should be running from the tap in a minute in order for the product to function properly. If the water pressure is above 1 MPa (10 Bars), a pressure-reducing valve should be fitted. The maximum allowed temperature is 25°C.
- Fit the end of the water discharge hose to the dirty water discharge drain, the sink or the bathtub.
- Place the power cable and houses in locations without risk of tripping.
- Do not install the product behind a door, a sliding door or at another location that will prevent the door from opening completely.
- If a drier is to be placed on the product, fix with a suitable connection apparatus obtained from the authorised service.
- There is a risk of contact with electrical pieces when the upper trays is removed. Do not dismantle the upper tray of the product.
- Place the product at least 1 cm away from the edges of furniture.



1.6 Operational Safety

- When you are using the appliances, use only detergents, softeners and supplements suitable for washing machines.

- Do not use chemical solvents on the product. These materials contain an explosion risk.
- Do not operate defective or damaged products. Unplug the product (or turn off the fuse it is connected to), turn off the water tap and call an authorised service.
- Do not place sources of ignition (burning candle, cigarettes, etc.) or sources of heat (irons, furnaces, ovens, etc.) on top of or near the product. Do not put inflammable/explosive materials near the product.
- Do not get on the product.
- Unplug the product and turn off the tap if you will not be using the product for long periods.
- Detergent/maintenance materials may splash out of the detergent drawer if it is opened while the machine is working. Contact of the detergent with your skin and eyes is dangerous.
- Make sure pets do not climb inside the product. Check inside the product before use.
- Do not force open the locked loading door. The door will open once the washing is completed. If the door does not open, use the solutions for “loading door does not open” error in the Troubleshooting section.
- Do not wash elements contaminated with gasoline, kerosene, benzene, reducers, alcohol or other inflammable or explosive materials and industrial chemicals.
- Do not directly use dry cleaning detergent and do not wash, rinse or spin laundry contaminated with dry cleaning detergent.
- Do not place your hands into the rotating drum. Wait until the drum no longer rotates.
- Do not place your hand or a metal object under the washing machine.
- If washing laundry at high temperatures, the discharged washing water would burn your skin if in contact with your skin, for ex. when the discharge hose is connected to the tap. Do not touch the discharge water.

- Take the following precautions to prevent formation of biofilm and malodours:
 - Make sure the room where the washing machine is placed is well ventilated.
 - Wipe the door gasket and loading door glass with a dry and clean cloth at the end of the programme.
- The glass of the loading door will heat up when washing at high temperatures. Therefore, do not touch the loading door glass while washing, especially children.

- Do not use sharp or abrasive tools to clean the product. Do not use household cleaners, soap, detergent, gas, gasoline, thinner, alcohol, varnish, etc. while cleaning.
- Cleaning agents containing solvents might reek poisonous fumes(for ex. cleaning solvent. Do not use cleaning products containing solvents.
- There may be detergent residues in the detergent drawer when you open it for cleaning.
- Do not dismantle the filter of the discharge pump while the product is running.
- The temperature in the machine may rise up to 90°C. Clean the filter after the water in the machine cools down in order to avoid risk of getting burnt.



1.7 Maintenance and Cleaning Safety

- Do not wash the product with pressure washers, by spraying vapour, water or pouring water.

2 Important Instructions for Environment

2.1 Compliance with WEEE Directive



This product complies with EU WEEE Directive (2012/19/EU). This product bears a classification symbol for waste electrical and electronic equipment (WEEE).

This product has been manufactured with high quality parts and materials which can be reused and are suitable for re-

cycling. Do not dispose of the waste product with normal domestic and other wastes at the end of its service life. Take it to the collection center for the recycling of electrical and electronic equipment. Please consult your local authorities to learn about these collection centers.

Compliance with RoHS Directive:

The product you have purchased complies with EU RoHS Directive (2011/65/EU). It does not contain harmful and prohibited materials specified in the Directive.

2.2 Package Information

Packaging materials of the product are manufactured from recyclable materials in accordance with our National Environment Regulations. Do not dispose of the packaging materials together with the domestic or other wastes. Take them to the packaging material collection points designated by the local authorities.

3 Technical Specifications

Supplier's name or commercial brand	Grundig
Model name	GWP810616MW
	7177882100
Nominal Capacity (kg)	10
Maximum spin speed (cycle/min)	1600
Built-In	No
Height (cm)	84
Width (cm)	60
Depth (cm)	58
Single Water inlet / Double Water inlet	+ / -
Electrical input (V/Hz)	230 V / 50Hz
Total current (A)	10
Total power (W)	2200
Main model code	1621



The consumption values apply when wireless network connection is turned off.

Symbols Table

Prewash	Fast	Fast+	Extra Rinse	Extra Water	Anfi Crease	Pet Hair Removal	Steam	Night Modu	Soaking	Rinse Hold	Steeping	AutoDose	Liquid Detergent Selection	Softener Selection	
Rinse	Spin+Drain	Drain	Temperature	Spin	No Spin	Tap Water (Cold)	No Water	Time Delay	Door Lock	Child Lock	On/Off	Start / Pause	Soil Level	Add Garment	Downloaded Program
Wash	Ok (End)	Cancel	Anti-Crease+	Drying	Extra Dry	Cupboard Dry	Iron Dry	Timed Drying	Clean&Wear						

4 Installation



Please read the "Safety Instructions" section first!



Your washing machine automatically detects the amount of laundry placed inside when selecting a program.

While installing the product, before the first use, calibration should be done to ensure that the laundry amount is detected in the most accurate way.

To do this, select the Drum Cleaning* program and cancel the spin function. Start the program without laundry. Wait for the program to finish, which will take about 15 minutes.

*The program name may vary depending on the model. For the appropriate program selection, review the program descriptions section.

- Preparation of the location and electrical, tap water and waste water installations at the place of installation is under customer's responsibility.
- Make sure that the water inlet and discharge hoses as well as the power cable are not folded, pinched or crushed while pushing the product into its place after installation or cleaning procedures.
- Prior to installation, visually check if the product has any defects on it. Do not have the product installed if it is damaged. Damaged products cause risks for your safety.

4.1 Appropriate Installation Location

- Place the product on a hard and level floor. Do not place it onto a carpet with high pile or other similar surfaces. Inappropriate floor may cause problems of noise and vibration

- Total weight of the washing machine and the dryer -with full load- when they are placed on top of each other reaches to approx. 180 kilograms. Place the product on a solid and flat floor that has sufficient load carrying capacity.
- Do not place the product on the power cable.
- Do not install the product at places where temperature may fall below 0 °C. Freezing might damage your product.
- Leave a minimum space of 1 cm between the product and the furniture.
- If you will install the product on a surface with steps, never place it close to the edge.
- Do not place the product on any platform.
- Do not place heat sources such as cooker, irons, ovens, heater etc. on the appliance and do not use them on the product.

4.2 Installation of Bottom Panel Cover

- In order to increase the sound comfort of the product, it is recommended to install the cover after removing the packaging foam.

Cover A

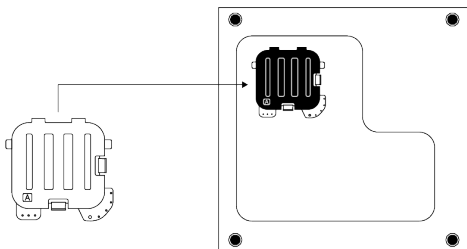

Tilt the machine back slightly. Rest the tabs of Cover A against the lower panel. Complete the assembly by rotating the cover.

4.3 Removing Transportation Safety Bolts

- Loosen all transportation safety bolts with an appropriate wrench until they turn freely.
- Bend the inner part by pressing it at the grip areas and pull the part out.
- Attach the plastic covers supplied in the User Manual bag into the holes on the rear panel.

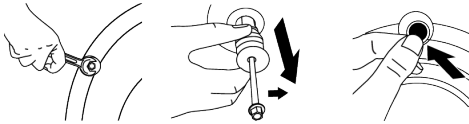

NOTICE

Remove the transportation safety bolts before operating the product. Otherwise, the product will get damaged.



NOTICE

Keep the transportation safety bolts in a safe place to reuse when the product needs to be moved again in the future.
Install the transportation safety bolts in reverse order of the disassembly procedure.
Never move the product without the transportation safety bolts properly fixed in place.

4.4 Connecting to Water Supply



NOTICE

Models with a single water inlet shall not be connected to the hot water tap. In such a case the laundry will get damaged or the product will switch to protection mode and will not operate.
Do not use old or used water inlet hoses on a new product. It may cause water leakage from your machine and stain your laundry.

- Tighten all hose nuts by hand. Never use a tool when tightening the nuts.
- Open the taps completely after making the hose connection to check for water leaks at the connection points. If any leak occurs, turn off the tap and remove the nut. Check the gasket and tighten the nut carefully again. In order to prevent the water leaks and resultant damages, keep the taps closed when you do not use the product.

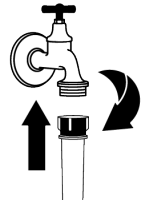

4.5 Connecting the Drain Hose to the Drain

- Attach the end of the drain hose directly to waste water drain, washbasin or bathtub.



Your house will be flooded if the water draining hose is dislocated during water draining. There is also a risk of burning due to the high washing temperatures. In order to prevent such situations and make sure that the product performs water intake and drain processes without any problem, fix the drain hose securely.

- Connect the drain hose to a minimum height of 40 cm and a maximum height of 100 cm.
- Installing the water draining hose at ground level or close to the floor (40 cm below) and then raising it makes water discharge difficult and the laundry may come out extremely wet. Thus, follow the heights provided in the figure.

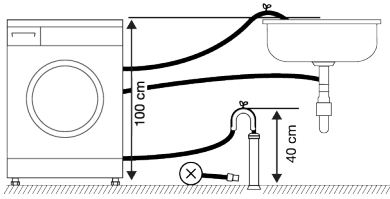

- d. To prevent the waste water to go back into the product again and to ensure easy drainage, do not immerse the end of the hose into the waste water or do not insert it into the drain for more than 15 cm. If it is too long, cut it short.
- e. The end of the hose should not be bent, it should not be stepped on and the hose must not be pinched between the drain and the product. Otherwise, water discharge issues may emerge.
- f. If the length of the hose is too short, use it by adding an original extension hose. The overall length of the hose shall not be longer than 3.2 m. To prevent water leaks, always secure the connection between the extension hose and the draining hose of the product with a suitable clamp so that it does not come off and cause leaks.

4.6 Adjusting the Stands



NOTICE

In order to ensure that the product operates more silently and vibration-free, it must stand level and balanced on its feet. Ensure that the product is balanced by adjusting the feet. Otherwise, the product may move from its place and cause crushing, noise and vibration problems.

To avoid damaging the lock nuts, do not use any tools to loosen the nuts.

- a. Loosen the lock nuts on the feet by hand.
- b. Adjust the feet until the product stands level and balanced.
- c. Tighten all lock nuts again by hand.

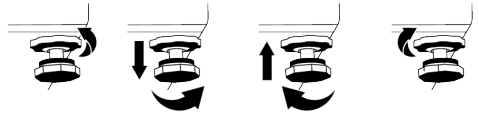

4.7 Electrical Connection

Connect the product to a grounded outlet protected by a 16 A fuse. Our company shall not be responsible for the damages that shall be incurred due to using the product without grounding according to local regulations.

- Connection must comply with national regulations.
- The electrical connection cable infrastructure of the product must be adequate and suitable for product requirements. It is recommended to use a residual current device.
- Power cable plug must be within easy reach after installation.
- If the current supply to the fuse or breaker in the house is less than 16 Amps, have a qualified electrician install a 16 amp supply.
- The voltage specified in the "Technical specifications" section must be equal to your mains voltage.
- Do not make connections via extension cables or multi-plugs. Overheating and burning may occur due to the connecting cable.



Damaged power cables should be replaced by the authorised service in order to prevent possible danger.

4.8 Start Up

Before starting to use the product make sure that the preparations described in section "Environmental instructions" and "Installation". To prepare the product for washing laundry, perform first operation in Drum Cleaning programme. If this programme is not available in your product, apply the method which is described in section "Cleaning the loading door and the drum".

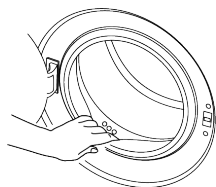

i Some water has remained in the product due to the quality control processes in the production. It is not harmful for the product.

5 Preliminary Preparation



Please read the “Safety Instructions” section first

5.1 Sorting the Laundry

- Sort laundry according to type of fabric, colour, and degree of soiling and allowable water temperature.
- Always observe the instructions given on the garment care labels.

5.2 Preparing Laundry for Washing

- Laundry items with metal attachments such as, underwiring, belt buckles or metal buttons will damage the product. Remove the metal pieces or wash such clothes by putting them in a laundry bag or pillow case.
- Take out all substances in the pockets such as coins, pens and paper clips, and turn pockets inside out and brush. Such objects may damage the product or cause noise problem.
- Put small size clothes such as infant’s socks and nylon stockings in a laundry bag or pillow case.
- Place curtains in without compressing them. Remove curtain attachment items. Curtain attachment items may cause pulling and tearing on the curtain.
- Fasten zippers, sew loose buttons and mend rips and tears.
- Wash “Machine washable” or “Hand washable” labelled products only with an appropriate programme.
- Do not wash colours and whites together. New, dark coloured cottons release a lot of dye. Wash them separately.

- Tough stains must be treated properly before washing.
- Wash trousers and delicate laundry turned inside out.
- Laundry that are subjected to materials such as flour, lime dust, milk powder, etc. intensely must be shaken off before placing into the product. Such dusts and powders on the laundry may build up on the inner parts of the product in time and can cause damage.

5.3 Tips for Energy and Water Saving

Following information will help you use the product in an ecological and energy/water-efficient manner.

- Operate the product in the highest load capacity allowed for the programme you have selected, but do not overload. See “Programme and consumption table”
- Observe the temperature instructions on the detergent packaging.
- Wash slightly soiled laundry at low temperatures.
- Use faster programmes for small quantities of lightly soiled laundry.
- Do not use prewash and high temperatures for laundry that is not heavily soiled or stained.
- If you plan to dry your laundry in a dryer, select the highest spin speed recommended during washing process.
- Do not use more detergent than the recommended amount on the detergent packaging.

5.4 Loading the Laundry

- a. Open the loading door.

- b. Put the laundry items into the product in a loose manner.
- c. Push the loading door to close until you hear a locking sound. Ensure that no items are caught in the door. The loading door is locked while a programme is running. The door lock will open once the programme is completed. Then you can open the loading door. If the door does not open, apply the solutions provided for "Loading door cannot be opened" error in the Troubleshooting section.

5.5 Correct Load Capacity

The maximum load capacity depends on the type of laundry, the degree of soiling and the desired washing programme.

The product automatically adjusts the water amount according to the weight of the laundry put inside it.



Follow the instructions in "Programme and consumption table". When the appliances is overloaded product's washing performance will drop. Moreover, noise and vibration problems may occur.

5.6 Using Detergent and Softener



WARNING

Read the manufacturer instructions on the package while using detergents, softeners, starch, bleach and decolourants, anti-limescale and follow the dosage information provided. Use a measuring cup, if any.

Gel-like, non-fluid liquid detergents, etc. cannot be used in the detergent compartments or dosing chambers.

Detergent, Softener and Other Cleaning Agents

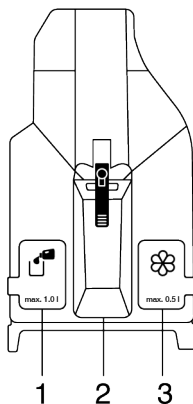

The detergent drawer comprises of three compartments:

- (1) Liquid detergent compartment
- (2) Powder detergent compartment
- (3) Softener compartment

- Add detergent and softener before starting the washing programme.
- Do not leave the detergent drawer open when the washing programme is on.
- Do not select a programme with pre-washing if you are using a detergent pod or dispensing ball. Place the detergent pod or the dispensing ball directly among the laundry in the product.
- Prewash compartment and prewash option is not available.

Choosing the Detergent type

Detergent type to be used depends on the washing programme, fabric type and colour.

- Use different detergents for coloured and white laundry.
- Wash your delicate clothes only with special detergents (liquid detergent, wool shampoo, etc.) intended solely for delicate clothes and at suggested programmes.
- When washing dark coloured clothes and quilts, it is recommended to use liquid detergent.
- Wash woollens at suggested programme with special detergent made specifically for woollens.

- Please review the programme descriptions part for suggested programme for different textiles.
- All recommendations about detergents are valid for selectable temperature range of programmes.



Only detergents, softeners and additives suitable for washing machines should be used. Do not use liquid detergents or other cleaning agents to soften the laundry. Do not use soap powder.

5.6.1 Automatic Dosing

Initial Installation

Turn on the machine with On/Off button.

Dosage symbol  appears in programs where detergent dosing is allowed. If the liquid detergent or softener compartments are empty, the dosage symbol will flash in programs where detergent dosing is allowed.

Filling Liquid Detergent and Softener

- Open the detergent compartment by pulling it towards yourself.

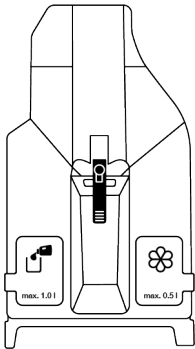

- To fill liquid detergent (left) and softener (right), open the related tank's lid by pulling it upwards as shown in the picture.

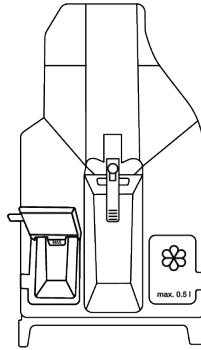

- Remember not to exceed the "Max" sign when adding liquid detergent or softener.
- Close the lid of the compartment.
- Close the detergent drawer by pushing lightly.
- After closing the detergent drawer, the flashing dosage symbol  starts lighting up continuously.
- It indicates that the compartments are filled successfully and the detergent drawer is in its place.

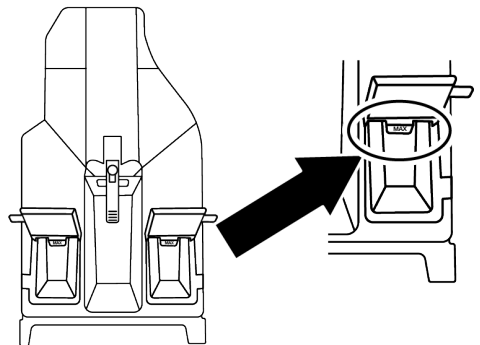

We recommend filling the detergent compartment with liquid detergents that can be used in common for coloured and white laundry.

If the detergent symbol is flashing even though the detergent compartments are filled, the detergent drawer is not seated properly. Push the drawer so that it is fully seated.

WARNING

When the detergent drawer is filled with detergent and/or softener; do not pull or move the equipment, and do not tilt it on either side or back. Before conducting these operations, the detergent drawer must always be removed from the machine. If you wish to start the program while there is no detergent in the detergent drawer, liquid detergent dosage must be cancelled and washing with powder detergent is required. Only liquid detergent must be put inside the liquid detergent dosing tank and only softener must be put in the softener dosing tank. Putting all kinds of liquid and powder chemicals together inside the tanks may damage your laundry or your machine.

5.6.2 Dosage Selections, Cancellation or Use of Powder Detergent

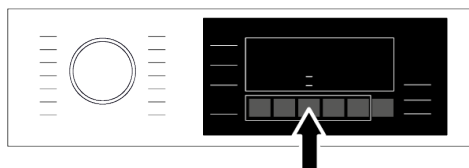









Liquid detergent cannot be selected in some of the programs. Powder detergent must be used in these cases. For more information, see Programme Table.

If powder detergent is to be used in programs where the detergent dosing system is operating, desired amount of detergent is put into the powder detergent compartment. If the detergent compartment in the middle is to be used, the automatic dosage selection must be deactivated.

Machine measures the load and determines the right amount of detergent depending on the load amount and the selections made previously. The detergent taken is not visible while washing, it is taken directly with water over the laundry.

If another liquid detergent with different properties than the one in the liquid detergent dosing tank is preferred to be used, liquid detergent with said different properties should be put in the powder detergent compartment in the middle and the liquid detergent dosage selection should be deactivated.

Softener will be taken from the dosing system.

Liquid detergent and softener dosing symbols become active or inactive according to the program selected on the screen.	
	First position on the display means liquid detergent is active, softener is on. If the liquid detergent and softener symbol is lit, it means that liquid detergent and softener dosing is active.
	
	If the liquid detergent and softener symbols are active on the screen; when you press the Automatic Dosing key for the first time, the liquid detergent will turn on and the softener will turn off. If the softener symbol is not lit, it means that softener will not be used in the rinsing step.
	
	When you press the Automatic Dosing key for the second time, the powder detergent and the softener will turn on. If the liquid detergent symbol is not lit, it means that it can be washed with powder detergent.
	
	When you press the Automatic Dosing key for the third time, the powder detergent will turn on and the softener will turn off. When you press it for the fourth time, it will return to the first position.
	

5.6.3 Detergent and/or Softener Running Out

When the detergent or the softener put inside the detergent drawer finishes, the dosage symbol in the display flashes. When this symbol flashes, it is necessary to add the decreasing detergent or softener to the

dosing tank. The product will be able to dose enough for 2-3 more cycles from the first moment the symbol flashes.

5.6.4 Filling Detergent or Softener into the Wrong Compartment

In case you fill the detergent or the softener in the wrong compartment, see "Cleaning the Detergent Drawer".

5.7 Tips for Efficient Washing

		Clothes			
		Light Colours and Whites	Colours	Black/Dark Colours	Delicates/Woolens/Silks
		(Recommended temperature range based on soil level: 40-90 °C)	(Recommended temperature range based on soil level: cool -40 °C)	(Recommended temperature range based on soil level: cool -40 °C)	(Recommended temperature range based on soil level: cool -30 °C)
Soiling Level	Heavily Soiled (difficult stains such as grass, coffee, fruits and blood.)	It may be necessary to pre-treat the stains or perform prewash. Powder and liquid detergents recommended for whites can be used at dosages recommended for heavily soiled clothes. It is recommended to use powder detergents to clean clay and soil stains and the stains that are sensitive to bleaches.	Powder and liquid detergents recommended for colours can be used at dosages recommended for heavily soiled clothes. It is recommended to use powder detergents to clean clay and soil stains and the stains that are sensitive to bleaches. Detergents which do not contain decolourant should be used.	Liquid detergents suitable for colours and black/dark colours can be used at doses recommended for heavily soiled clothes.	Prefer liquid detergents produced for delicate clothes. Woollen and silk clothes must be washed with special woollen detergents.
	Normally Soiled (For example, stains caused by body on collars and cuffs)	Powder and liquid detergents recommended for whites can be used at dosages recommended for normally soiled clothes.	Powder and liquid detergents recommended for colours can be used at dosages recommended for normally soiled clothes. Detergents which do not contain decolourant should be used.	Liquid detergents suitable for colours and black/dark colours can be used at doses recommended for moderately soiled clothes.	Prefer liquid detergents produced for delicate clothes. Woollen and silk clothes must be washed with special woollen detergents.
	Lightly Soiled (No visible stains exist.)	Powder and liquid detergents recommended for whites can be used at dosages recommended for lightly soiled clothes.	Powder and liquid detergents recommended for colours can be used at dosages recommended for lightly soiled clothes. Detergents which do not contain decolourant should be used.	Liquid detergents suitable for colours and black/dark colours can be used at doses recommended for lightly soiled clothes.	Prefer liquid detergents produced for delicate clothes. Woollen and silk clothes must be washed with special woollen detergents.

5.8 Displayed Programme Duration

You can view the programme duration on the display of your machine while selecting a programme. Depending on the amount of laundry you have loaded into your machine, foaming, unbalanced load conditions, fluctuations in power supply, water pressure and

programme settings, the programme duration is automatically adjusted while the programme is running.

SPECIAL CASE: At programme start of Cottons and Cotton Eco programmes, display shows the duration of half load. It is the most common use case. After programme starts, in 20-25 minutes actual load is detected by the machine. And if the detected load is higher than half load; washing programme

will be adjusted accordingly and programme duration increased automatically. You can follow this change on the display.

6 Operating the Product



Please read the "Safety Instructions" section first!

6.1 Control Panel

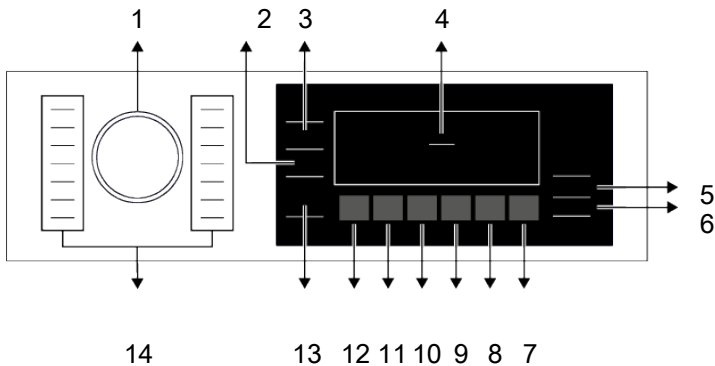

- | | |
|--------------------------------|--------------------------------|
| 1 Programme Selection Button | 2 Spin Speed Adjustment Button |
| 3 Temperature Setting Button | 4 Display |
| 5 ON/OFF Button | 6 Start/Pause Button |
| 7 End Time Setting Button | 8 Auxiliary Function Button 5 |
| 9 Auxiliary Function Button 4 | 10 Auxiliary Function Button 3 |
| 11 Auxiliary Function Button 2 | 12 Auxiliary Function Button 1 |
| 13 Remote Control Button | 14 Programme selection LEDs |

6.2 Symbols on the Display

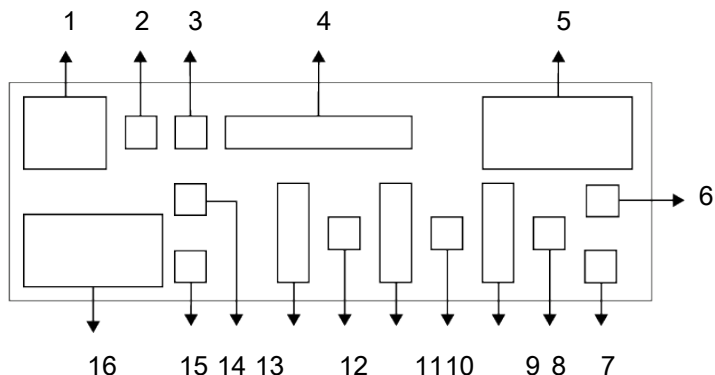

- | | |
|---|--|
| 1 Temperature Indicator | 2 Wireless Connection Indicator |
| 3 Remote Control Indicator | 4 Programme follow-up indicator |
| 5 Duration information | 6 Programme Start Indicator |
| 7 Delayed Start Enabled Indicator | 8 Door Lock Engaged Indicator |
| 9 Auxiliary Function Indicators 5 | 10 Child Lock Engaged Indicator |
| 11 Auxiliary Function Indicators 4 | 12 No Water indicator |
| 13 Auxiliary function (Dosing) Indicators 3 | 14 Auxiliary Function (Support Service) Indicators 1 |
| 15 Auxiliary Function Indicators 2 | 16 Spin Speed Indicator |



The visuals used for machine description in this section are schematic and may not match exactly with the features of your machine.

6.3 Programme and Consumption Table

Programme						Auxiliary Functions					Temperature °C
	Temperature °C	Max. Load (kg)	Water Consumption (l)	Energy Consumption (kWh)	Max. Speed	Steam	ProDose	Pet Hair Removal	Anti Crease+	Express / Intensive	
Cottons	90	10	98	2,75	1600	•	•	•	•	•	Cold - 90
	60	10	98	2,00	1600	•	•	•	•	•	Cold - 90
	40	10	95	1,10	1600	•	•	•	•	•	Cold - 90
Cottons Eco	60**	10	59	1,15	1600		•				Cold - 60
	60**	5	41,5	0,82	1600		•				Cold - 60
	40**	5	41,5	0,795	1600		•				Cold - 60
Synthetics	60	4	76	1,60	1200	•	•	•	•	•	Cold - 60
	40	4	74	1,10	1200	•	•	•	•	•	Cold - 60
Mini / Mini 14'	90	10	75	2,30	1200	•	•		•	•	Cold - 90
	60	10	75	1,30	1200	•	•		•	•	Cold - 90
	30	10	75	0,25	1200	•	•		•	•	Cold - 90
Mini / Mini 14' + Quick Wash	30	2	45	0,15	1200	•	•		•	•	Cold - 90
WoolProtect / Hand Wash	40	2	60	0,60	1200		•				Cold - 40
Shirts	60	4	70	1,40	800	*	•	•	•	•	Cold - 60
MachineCare	90	-	74	1,10	600	*					90
Bedding / Down Wear	60	-	100	1,60	800	•	•				Cold - 60
HygieneCare+	90	9	125	3,00	1600	*	•				20-90
Supreme Refresh		1	1,1	0,11	-	*					-
SenseWash	60	10	****	****	1600		•		•	•	Cold - 60
Downloaded Program											
StainCare	60	5	86	1,85	1600		•			•	30-60
Sports	40	5	60	0,65	1200		•				Cold - 40
Dark Care / Jeans	40	5	86	1,05	1200	•	•	•	•	•	Cold - 40
Towel	60	4	115	1,60	600	•	•				Cold - 60
Soft Toys	40	2	80	0,90	600		•				Cold - 40

• : Selectable.

* : Automatically selected, cannot be cancelled.

*** : Energy label programme (SANS 1695)

**** : These programmes can be used with the HomeWhiz application. Power consumption may increase due to the connection.

- : See the programme description for maximum load.



Please read Installation section of the manual before first use.

The auxiliary functions in the table may vary according to the model of your machine.

Water and energy consumption may vary subject to the changes in water pressure, water hardness and temperature, ambient temperature, type and amount of laundry, selection of auxiliary functions and spin speed, and changes in electric voltage. Selection patterns for auxiliary functions can be changed by the manufacturer company. New selection patterns can be added or removed. The spin speed of your machine may vary according to the programme; this spin speed cannot exceed the max. spin speed of your machine. The amount of noise and humidity varies according to the spin speed; when the higher spin speed is selected during the spinning phase, the laundry contains less moisture but higher noise occurs at the end of the programme.



You can see the washing duration on the display of your machine while selecting a programme. Depending on the amount of laundry you have loaded into your machine, there may be a difference of 1-1.5 hours between the duration shown on the display and the actual duration of the wash cycle. Duration will be automatically updated soon after the washing starts.

Always select the lowest appropriate temperature. The most efficient programmes in terms of energy consumption are generally those that wash at low temperatures for a long time.

6.4 Programme Selection

- Determine the programme suitable for the type, quantity and soiling level of the laundry in accordance with "Programme and consumption table".



Programmes are limited to the highest spin speed appropriate for that particular type of fabric.

When selecting a programme, always consider the type of fabric, colour, soiling level and permissible water temperature.

- Select the desired programme with the Programme Selection knob.

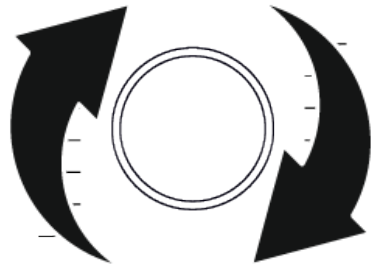

6.5 Programmes

• AquaTech

When this function is activated, water inside the drum is sent to clothes with a shower effect through a special flap. Cycle durations shorten and a more sensitive and high performance washing is provided for your clothes. The special rinsing movement designed for delicate clothes (e.g. woollen) works with this technology to wash your laundry quite delicately. This function operated with the fast stirring movement for highly dirty cotton clothes cleans your clothes with higher performance.

The application time and period of this operation is designed to optimize the best result according to the features of the washing programmes. Generally, this system is activated at a point between 25 to 60 minutes into the wash cycle, depending on the load

and temperature selection. In certain programmes, spraying system will be activated at the beginning of the cycle. The spraying system starts within 3 to 10 minutes in these programmes.

• **Cottons Eco**

Use to wash your normally soiled, durable cotton and linen laundry. Although it washes longer than all other programmes, it provides high energy and water savings. Actual water temperature may be different from the stated wash temperature. When you load the machine with less laundry (e.g. ½ capacity or less), periods in programme stages may automatically get shorter. In this case, energy and water consumption will decrease.

• **Cottons**

You can wash your durable cotton laundry (sheets, bedlinen, towels, bathrobes, underwear etc.) in this programme. When the quick wash function button is pressed, programme duration becomes notably shorter but effective washing performance is ensured with intense washing movements. If the quick wash function is not selected, effective washing and rinsing performance is ensured for your heavily soiled laundry.

• **Synthetics**

You can wash your laundry (such as t-shirts, blouses, synthetic/cotton blended fabrics etc.) in this programme. When the quick wash function button is pressed, programme duration becomes notably shorter and effective washing performance is ensured for your lightly soiled laundry. If the quick wash function is not selected, effective washing and rinsing performance is ensured for your heavily soiled laundry.

• **WoolProtect / Hand Wash**

Use to wash your woollen/delicate laundry. Select the appropriate temperature complying with the tag of your clothes. Your laundry will be washed with a very gentle washing action in order not to damage the clothes.

• **HygieneCare+**

Applying a steam step at the beginning of the programme allows to soften the dirt easily.

Use this programme for your laundry (baby clothes, bed sheets, bedlinen, underwear, etc. cotton items) that requires an anti-allergic and hygienic washing at high temperature with intensive and long washing cycle. The high level of hygiene is ensured thanks to the steam application before the programme, long heating duration and additional rinsing step.

- Programme was tested by „The British Allergy Foundation,, (Allergy UK) with the 60°C temperature option selected and it was certified in terms of its efficacy in eliminating allergens in addition to bacteria and mould.



Allergy UK is the brand of the British Allergy Association. Seal of Approval is created to guide people that require recommendation about a product that the related product restricts / reduces / eliminates the allergens or reduces the allergen content significantly in the ambient where allergy patients exist. It aims to provide assurance that the products are tested scientifically or examined in a way to provide measurable results.

- Use this programme to wash your fibre duvets that bear "machine washable" tag. Check that you have loaded the duvet correctly in order not to damage the machine and the duvet. Remove the duvet cover before loading the duvet into the machine. Fold the duvet into two and load it into the machine. Load the duvet into the machine while paying attention that it will not contact the door gasket or the glass. Steam is applied at the end of the programme to soften bulky laundry such as towels.



Do not load more than 1 double fibre duvet (200 x 200 cm).

Do not wash your duvets, pillows and etc. that contain cotton filling in the machine.



Do not use the washing machine to wash materials such as carpets, rugs etc. Otherwise, your machine may be damaged permanently.

• Spin + Pump

You can use this program to remove the water on the garment/inside the machine.

• Rinsing

Use when you want to rinse or starch separately.

• Supreme Refresh

Use this programme to reduce the creases and ironing times of a small amount of unspotted cotton, synthetic or mixed laundry.

• Shirts

This programme is used to wash the shirts made from cotton, synthetic and synthetic blended fabrics altogether. It reduces wrinkles. Steam is applied at the end of the programme to help the wrinkle reducing function. The special spin profile and steam applied at the end of the programme reduce the wrinkles on your shirts. When the quick wash function is selected, the Pre-treatment algorithm is executed.

- Apply the pre-treatment chemical on your garments directly or add it together with the detergent in the powder detergent compartment. Thus, you can obtain the same performance as you obtain with normal washing in a much shorter period of time. Usage life of your shirts increases. Do not use pre-wash detergent if you are planning to use delay function of your machine. Pre-wash detergent may cause stains on your clothes.

** It is recommended to operate the cycle with no more than 6 shirts to minimise the wrinkle level in your shirts with this cycle. When washing is operated with more than 6

shirts, there may be differences on the wrinkle levels and humidity on shirts at the end of cycle.

• Mini / Mini 14'

Use this programme to wash your lightly soiled or unspotted cotton clothes in a short time but not for towels or heavy cottons. The programme duration can be reduced down to 14 minutes when the quick wash function is selected. When the quick wash function is selected, maximum 2 (two) kg of laundry must be washed.

• Dark Care / Jeans

Use this programme to protect the colour of your dark-coloured garments or jeans. It ensures high performance washing with special drum movement even if the temperature is low. It is recommended to use liquid detergent or woollen shampoo for dark coloured laundry. Do not wash your delicate clothes containing wool or etc.

• MachineCare

Regularly clean (once every 1 to 2 months) the drum for ensuring the required hygiene. Turn on the programme when the machine is completely empty. For better results, use powder anti-limescale (drum cleaning materials) suitable for washing machines when the powder detergent function is selected. Leave the loading door half closed after the programme ends for the inside of the machine to dry.



This is not a washing programme.

This is a maintenance programme.

Do not turn this programme on when there is something inside the machine. When you attempt to operate, the machine automatically senses that there is load inside, and may quit or resume the programme as per the model of your machine. An effective cleaning is not achieved if the programme is resumed.

• SenseWash

Use to wash frequently washable cotton, synthetic or blended (cotton+synthetic) clothes. Programme detects the type and

quantity of the laundry to automatically adjust water consumption and programme time.



WARNING

Do not wash your woollen and delicate clothes in this programme.

The maximum washing temperature in Automatic programme depending on the soiling level and laundry type is 60°C. Washing performance may not be at the desired level for heavily soiled whites and stubborn stains (collar, sock soil, perspiration stain, etc.). In this case, it is recommended to select Cottons programme with prewash and set the temperature to 50-60°C.

Many types of clothing are correctly detected and safely washed in Automatic programme.

• **Sports**

You can use this programme to wash sports and outdoors garments that contain cotton/synthetics mix and water repellent covers such as gore-tex etc. It makes sure your garments are washed gently thanks to special rotating movements.

• **StainCare**

The machine has a special stain programme which enables the removal of different types of stains in the most effective way. Use this programme only for durable colourfast cotton laundry. Do not wash delicate and pig-menting clothes and laundry in this programme. Before washing, garment tags should be checked (recommended for cotton shirts, trousers, shorts, t-shirts, baby clothes, pyjamas, aprons, table clothes, bed sheets, duvet covers, pillowcases, bath-beach towels, towels, socks, cotton underwear that are suitable for washing at high temperature and long time)..

You may wash 24 stain types shown below as classified in three different groups that may be selected with the “Quick/Intense” setting key on the auto stain programme. Depending on the selected stain group, a

special washing programme for which duration of rinse hold, washing action, washing and rinsing duration are modified.

Below you can find the soil groups that can be selected with the “Quick/Intense” setting key:

When “Intense” is selected;

Sweat, collar dirt, food, mayonnaise, salad dressing, make-up, machine oil, baby food.

When “Quick/Intense” is not selected;

Blood, chocolate, pudding, grass, mud, eggs, butter, curry.

When “Quick” is selected;

Tea, coffee, juice, ketchup, red wine, cola, jam, coal

- a. Select the stain programme.
- b. Select the stain you want to clean by locating it in the groups above and selecting the related group with the Quick/Intense auxiliary function button.
- c. Read the garment tag carefully and ensure that correct temperature and spin speed are selected.

• **Downloaded Program**

This is a special programme that allows you to download different programmes when you want to. At the start, there is a programme you can see with the HomeWhiz application as default. However, you can use the HomeWhiz application to select a programme from the predefined programme set, and then change and use it.



Select Programme Download feature if you want to use HomeWhiz feature and Remote Control function. Detailed information can be found in HomeWhiz Feature and Remote Control Function.

• **Soft Toys**

Soft toys must be washed in a delicate programme due to their delicate fabrics, and the fibre and accessories they contain. Thanks to its delicate washing movements and spin-

ning profile, the soft toys programme protects the toys during washing. It is recommended to use liquid detergent.

i Fragile toys with hard surfaces must not be washed under any circumstances, Toys must not be washed together with your garments since they may harm laundry.

• Towel

Use this programme to wash durable cotton laundry such as towels. Load the towels into the machine paying attention to place them in a way that they will not contact the door gasket or the glass.

6.6 Temperature Selection

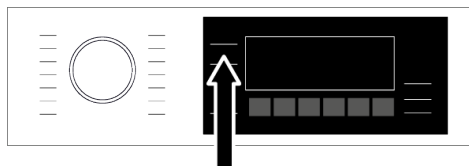

Whenever a new programme is selected, the recommended temperature for the programme appears on the temperature indicator. It is possible that the recommended temperature value is not the maximum temperature that can be selected for the current programme.

Press the Temperature Adjustment button to change the temperature. Temperature decreases gradually.

i No change can be made in programmes where temperature adjustment is not allowed.

You can also change the temperature after the washing starts. This change can be made if the only washing steps allow it.

i If you scroll to cold wash option and press Temperature Adjustment button again, the recommended maximum temperature for the selected programme appears on the display. Press the Temperature Adjustment button again to decrease the temperature.

6.7 Spin Speed Selection

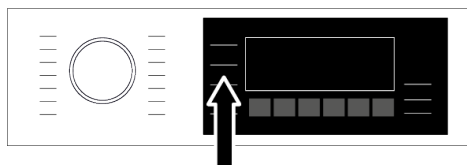

Whenever a new programme is selected, the recommended spin speed of the selected programme is displayed on the Spin Speed indicator. It is possible that the recommended spin speed value is not the maximum spin speed that can be selected for the current programme.

Press the Spin Speed Adjustment button to change the spin speed. Spin speed decreases gradually.

Then, depending on the model of the product, "Rinse Hold | |" and "No Spin _" options appear on the display.

If you are not going to unload your laundry immediately after the programme completes, you can use Rinse Hold function in order to prevent them from getting wrinkled when there is no water in the machine.

This function holds the laundry in the final rinsing water. If you want to spin your laundry after the Rinse Hold function:

- Adjust the Spin Speed.
- Press Start / Pause. The programme will resume. Machine drains the water and spins the laundry.

If you want to drain the water at the end of the programme without spinning, use No Spin function.

i No change can be made in programmes where spin speed adjustment is not allowed.

You can change the spin speed after the washing starts if the washing steps allow it. Changes cannot be made if the steps do not allow it.

Rinse Hold

If you are not going to unload your clothes immediately after the programme completes, you can use rinse hold function to keep your laundry in the final rinsing water in order to prevent them from getting wrinkled when there is no water in the machine. Press Start/Pause button after this process if you want to drain the water without spinning your laundry. Programme will resume and complete after draining the water.

If you want to spin the laundry held in water, adjust the Spin Speed and press Start/Pause button. The programme will resume. Water is drained, laundry is spun and the programme is completed.

6.8 Auxiliary Function Selection

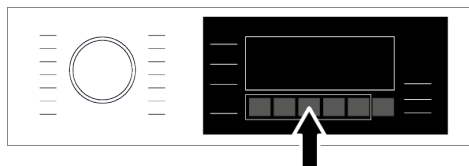

Select the desired auxiliary functions before starting the programme. Whenever a programme is selected, icons of the auxiliary function symbol that is selected together with it illuminates.

Also the frames of the auxiliary functions selected for the current programme after the washing has started remain illuminated.



When an auxiliary function button that cannot be selected with the current programme is pressed, the washing machine will make a warning sound.

Some functions cannot be selected together. If a second auxiliary function conflicting with the first one is selected before starting the machine, the function selected first will be cancelled and the second auxiliary function selection will remain active. For example, if you want to select Quick Wash after you have selected the Additional Water, Additional Water will be cancelled and Quick Wash will remain active.

An auxiliary function that is not compatible with the programme cannot be selected. (See "Programme and consumption table")

Some programmes have auxiliary functions that must be operated simultaneously. Those functions cannot be cancelled. The frame of the auxiliary function will not be illuminated, only inner area will be illuminated.

6.8.1 Auxiliary Functions

• Express / Intensive

You may reduce or increase the programme period with this function. The increase or decrease rates may vary as per the selection of the programme. When the QUICK or INTENSE LEDs are not illuminated, the proper programme period for your normally soiled laundry is indicated.

Intense mode may be selected automatically as per the programme selection. The Intense LED on the panel shall be illuminated in this case. You may use Intense selection to achieve a better washing performance while washing heavily soiled laundry.

You may shorten the programme duration by using the Quick/Intense key for your lightly soiled laundry on programmes where Intense

mode is selected as default. When you press the button once, the LED shall be turned off and you shall access the proper programme period for your normally soiled laundry. When you press the same button for the second time, the Quick LED shall be illuminated and the duration shall be reduced further and it shall display the minimum programme period suitable for your lightly soiled laundry. The duration of programmes may shorten by 50% when this function is selected. Thanks to the optimized washing steps, high mechanical operation capability and optimum water consumption, a higher washing performance is achieved although the duration is shorter.

• **Pet Hair Removal**

This function helps to remove pet hair that remain on your garments more effectively. When you select this function, Prewash and Extra Rinse steps are added to the normal programme. Thus, washing is performed with more water and the pet hair is removed more effectively.

• **Steam**

This function helps reducing the wrinkles on your cotton, synthetic and mixed laundry, shortening the ironing times, and removing the stains by softening them.

* Under conditions where the steam function is applied at the end of the programme, your laundry may be warmer at the end of the washing. This is expected within the programme working conditions.



Do not use liquid detergents if no liquid container or liquid detergent dosing feature is available. There is the risk of staining of the clothes.

• **ProDose**

You can change your dosage and detergent preferences with this auxiliary function key. For detailed information, see "Dosage Selection, Cancellation or Use of Powder Detergent"

• **Remote Control**

You can use this auxiliary function key to connect your product to smart devices. For detailed information, see HomeWhiz Function Feature and Remote Control Function.

• **Customized Programme**

This auxiliary function can only be used for Cotton and Synthetics programmes together with the HomeWhiz application. When this auxiliary function is activated, you can add up to 4 auxiliary rinsing steps to the programme. You can select and use some auxiliary functions even though they are not found on your product. You can increase and decrease the duration of the Cottons and Synthetics programmes within a safe range.



When the Programme Personalisation auxiliary function is selected, the washing performance and energy consumption will be different than the declared value.

6.8.2 **Functions/Programmes Selected by Pressing the Function Keys for 3 Seconds**

• **Anti Crease+**

This function is selected when the spin selection button is pressed and held for 3 seconds and the programme follow-up light for the relevant step turns on. When the function is selected, the drum rotates for up to 8 hours for preventing the laundry from creasing at the end of the programme. You can cancel the programme and take your laundry out at any time during the 8-hour duration. Press the function selection key or the machine on/off key to cancel the function. The programme follow-up light will remain on until the function is cancelled or the step is complete. If the function is not cancelled, it will be active in the subsequent washing cycles as well.

• Automatic Dosage Setting

Activates by pressing down the related auxiliary function key (Automatic Dosage) for 3 seconds. Liquid Detergent or Softener dosage amount can be changed with this function.

Changing liquid detergent and softener dosage settings:

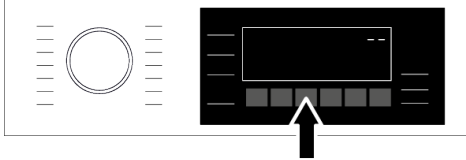

- Press and hold Automatic Dosage key for 3 seconds.



- The liquid detergent dosage level settings can be changed by pressing down “Temperature” selection key as shown below:

d1: Low
d2: Medium
d3: High

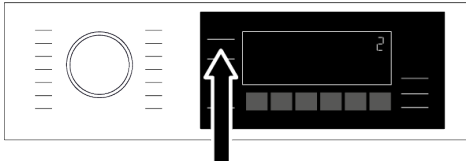

- The softener dosage level settings can be changed by pressing down “Spin” selection key as shown below:

s1: Low
s2: Medium
s3: High

When dosage amount setting process is completed, you can return to the main menu by pressing the automatic dosage key. Until a new setting is selected, dosing will be done according to the latest setting you have selected in all programs.

• Child Lock

Use Child Lock function to prevent children from tampering with the machine. Thus you can avoid any changes in a running programme.

 You can switch on and off the machine with On / Off button when the Child Lock is active. When you switch on the machine again, programme will resume from where it has stopped.

When the Child Lock is enabled, an audio warning will be given if the buttons are pressed. Audio warning will be cancelled if the buttons are pressed five times consecutively.

To activate the child lock:

Press and hold the related auxiliary function button for 3 seconds. After the countdown as “3-2-1” on the display is over, Child Lock symbol appears on the display. When this warning is displayed, you can release the Auxiliary Function button 3.

To deactivate the child lock:

Press and hold the related auxiliary function button for 3 seconds. After the countdown as “3-2-1” on the display is over, Child Lock symbol disappears.

• Wireless Connection

You can match your machine and your smart devices with the wireless connection. This way, you can use your smart device to get information about your machine and control it.

To activate wireless connection:

Press and hold Remote Control button for 3 seconds. After countdown “3-2-1” on the display ends, “On” symbol appears. When this notification is displayed stop pressing the remote control button. The wireless connection icon blinks when the product is connecting the internet. If connection is successful, icon will remain on.

To deactivate wireless connection:

Press and hold Remote Control button for 3 seconds. Countdown “3-2-1” will be displayed, and then “Off” symbol will appear on the display.



To be able to enable wireless connection, machine setup should be completed through HomeWhiz application. After setup, wireless connection will be enabled automatically if you press “Remote Control” button.

6.9 End Time

Time display

When the end time function is selected, the remaining time until the programme starts is shown in hours such as 1h, 2h, and the remaining time to complete the programme after your programme starts is shown in hours and minutes as in the 01:30 example.



Programme duration may differ from the values in section "Programme and consumption table" depending on the water pressure, water hardness and temperature, ambient temperature, amount and the type of laundry, auxiliary functions selected and the changes at the mains voltage.

After a certain period of time after the end time function is activated, the machine goes into standby mode and some LEDs on the screen turn off. If there is any user input, the LEDs will turn on again.

With the End Time function, the start-up of the programme may be delayed up to 24 hours. After pressing End Time Setting button, the programme's estimated ending time is displayed. If the End Time is set, End Time Setting indicator is illuminated.

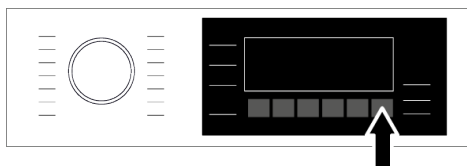

In order for the End Time function to be activated and the programme to be completed at the end of the specified time, you must press Start/Pause button after adjusting the time.

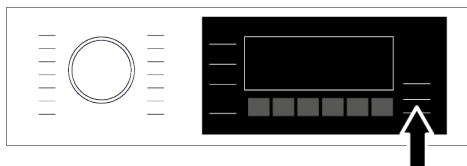

If you want to cancel the End Time function, turn off and on the product by pressing the On/Off button.

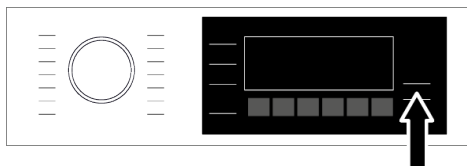

When you have activated the End Time function, do not add liquid detergent in the powder detergent compartment no 2. There is the risk of staining of the clothes

- Open the loading door, place the laundry and put detergent, etc.
- Select the washing programme, temperature, spin speed and, if required, the auxiliary functions.
- Set the end time of your choice by pressing the End Time Setting button. End Time Setting indicator illuminates.
- Press Start / Pause. Time countdown starts.

i Additional laundry can be added into the machine during the End Time countdown. At the end of the countdown, End Time indicator turns off, washing cycle starts and the time of the selected programme appears on the display.

6.10 Starting the Programme

- Press Start / Pause button to start the programme.

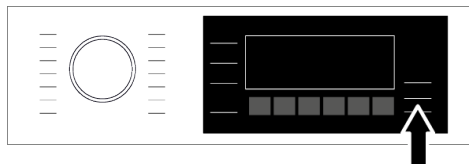

- Loading door is locked. The door lock symbol appears on the display after the loading door is locked.
- Programme follow-up indicator lights on the display will show the current programme step.

i If no programme is started or no button is pressed within 10 minutes during programme selection process, the product will automatically turn off. Display and all indicators turn off. If you press On / Off button, the default selected programme information is displayed.

6.11 Loading Door Lock

There is a locking system on the loading door of the machine that prevents opening of the loading door in cases when the water level is unsuitable.

"Door Locked" symbol appears on the display when the loading door is locked.



i The door will be locked if Remote Control Function is selected. In order to open the door you must deactivate Remote Start Function by either pressing the Remote Start button or changing the programme position.

Opening the loading door in case of power failure:

i In case of power failure, you can use the loading door emergency handle under the pump filter cap to open the loading door manually.

! To avoid any water overflow before opening the loading door, make sure there is no water left inside the machine.

- Turn off and unplug the appliance.
- Open the pump filter lid.

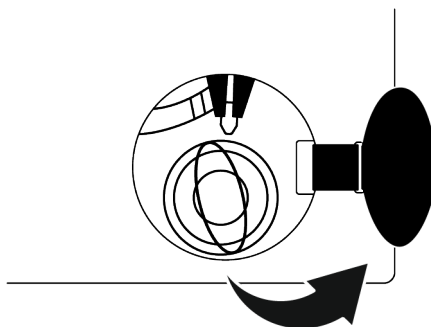

- Pull down the loading door emergency handle with a tool and release. Then open the loading door.
- If the loading door does not open then repeat the previous step.

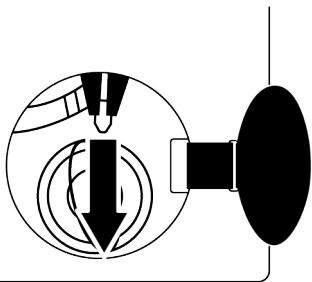

6.12 Changing the Selections After Programme has Started

Adding laundry after the programme has started

If the water level in the machine is suitable when you press Start/Pause button, the door lock will be deactivated and the door will open, allowing you to add garments. The door lock icon on the display goes off when the door lock is deactivated. After adding garments, close the door and press Start/Pause button once again to resume the washing cycle.

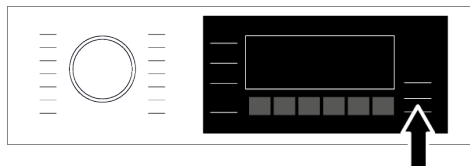

If the water level in the machine is not suitable when you press Start/Pause button, the door lock cannot be deactivated and the door lock icon on the display remains on.

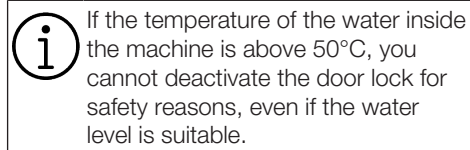

If the temperature of the water inside the machine is above 50°C, you cannot deactivate the door lock for safety reasons, even if the water level is suitable.

Switching the machine to pause mode:

Press the Start/Pause button to switch the machine to pause mode. Pause symbol will flash on the display.

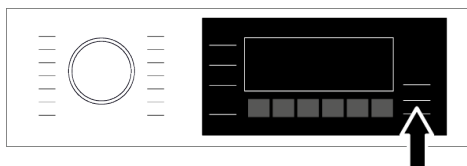

Changing the programme selection after programme has started:

Programme cannot be changed when a programme is running. You need to pause the operating programme if the Child Lock is not active and select a new programme. This action will cancel the current programme.

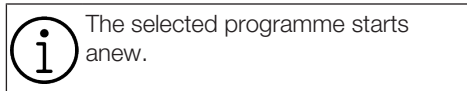

The selected programme starts anew.

Changing the auxiliary function, speed and temperature:

Depending on the step the programme has reached, you can cancel or activate the auxiliary functions. See "Auxiliary Function Selection"

You can also change the speed and temperature settings. See "Spin Speed Selection" and "Temperature Selection".

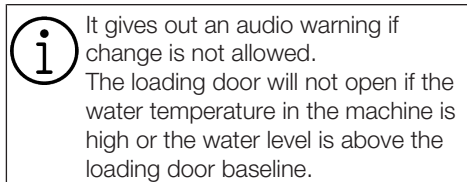

It gives out an audio warning if change is not allowed. The loading door will not open if the water temperature in the machine is high or the water level is above the loading door baseline.

6.13 Cancelling the Programme

When the machine is turn on and off the programme gets cancelled. Press and hold On/Off button for 3 seconds.

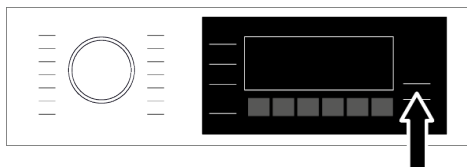



If you turn the programme selection button when the Child Lock is enabled, the programme will not be cancelled. You should cancel the Child Lock first.

If you want to open the loading door after you have cancelled the programme but it is not possible to open the loading door since the water level in the machine is above the loading door baseline, then turn the Programme Selection knob to Pump+Spin programme and drain the water in the machine.

6.14 End of Programme

End warning appears on the display when the programme is completed.

The product automatically shuts down if no buttons are pressed for 10 minutes. Display and all indicators are turned off.

Completed programme steps will be displayed if you press the On/Off button.

6.15 HomeWhiz Feature and Remote Control Function

HomeWhiz enables you to control your washing machine by using your smart appliance and get information about the status of the machine. With HomeWhiz application, you can use your smart appliance to perform various operations on the machine. Furthermore, you can use some features only with HomeWhiz function.

In order to use the Bluetooth feature of your machine, you must download HomeWhiz application from the application store of your smart appliance.

Make sure your smart appliance is connected to the internet to install the application. If you are using the application for the first time, please follow the instructions on the screen to complete your user account registration. Once the registration procedure is complete, you can use all products with the HomeWhiz feature in your house on this account.

You can touch the “Appliances” tab in the HomeWhiz application to view appliances paired with your account. Following the installation of the application, HomeWhiz function enables the washing machine to send you instant notifications via your smart appliance.



In order to use the HomeWhiz function, the application must be installed on your smart appliance, and your washing machine must be paired with your smart appliance via Bluetooth. If your washing machine is not paired to your smart device it works as an appliance which does not have a HomeWhiz feature.

Your product will operate as paired to your smart device via bluetooth.

The controls made by means of the application will be enabled through this pairing. Therefore the bluetooth signal strength between the appliance and the smart device must be adequate.

Please visit www.homewhiz.com to see the Android and iOS versions supported by the HomeWhiz application.



All the safety measures described in "**GENERAL SAFETY INSTRUCTIONS**" section of your user manual apply to the remote operation through HomeWhiz function as well

6.15.1 HomeWhiz Setup

In order for the application to run, a connection between your appliance and the HomeWhiz Application must be established. For this connection to be established you must follow the steps below for setup procedure on both the appliance and the HomeWhiz Application.

- a. If you are adding a device for the first time, touch “Appliances” tab on the HomeWhiz Application. Select “ADD AP-

PLIANCE" (touch here for setting up a new appliance) button in the upper right corner. Perform the setup by following both the steps below and the steps in the HomeWhiz Application.

- b. To start the setup, make sure that your machine is turned off. Press and hold the On/Off button and the Remote Control Function button simultaneously for 3 seconds to switch your machine to HomeWhiz setup mode.

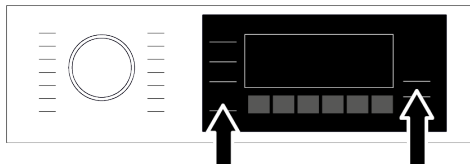

- c. When the appliance is in HomeWhiz setup mode, you will see an animation on the display and the bluetooth icon will flash until your machine gets paired with smart device. Only programme knob will be active in this mode. Other buttons will be inactive.

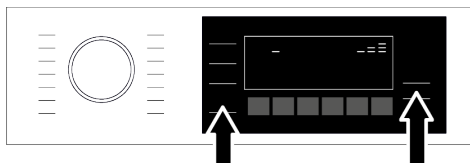

- d. Follow the instructions on the display of HomeWhiz application.
- e. Wait until the installation is complete. When setup is complete, give your washing machine a name. Now, you can tap and see the product you have added in the HomeWhiz Application.



Your washing machine will automatically turn off if you cannot realize the setup successfully within 5 minutes. In this case, you have to start the setup process all over again. If the problem continues, please contact the Authorised Service.

You can use your washing machine with more than one smart device. To do this, download the HomeWhiz app on the other smart device as well. When you launch the app, you will need to log in with the account you previously created and paired with your washing machine. Otherwise, please read "Setting up a washing machine that is connected to someone else's account".



You need internet connection on your smart device to proceed with HomeWhiz setup. Otherwise, the HomeWhiz application will not let you finish the setup procedure successfully. Please contact your internet service provider if you are having problems with your internet connection.

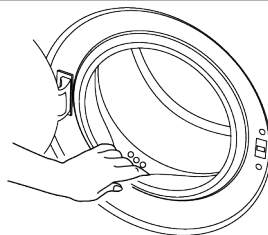

HomeWhiz Application may require you to type the product number shown on the product label. You can find the product label inside the appliance door. The product number is located on this label.



6.15.2 Setting up a Washing Machine Connected to Someone Else's Account

If the washing machine that you want to use has been previously registered to the system with someone else's account, you need to establish a new connection between your HomeWhiz App and the appliance.

- Download HomeWhiz Application on the new smart device you want to use.
- Create a new account and log in to this account on the HomeWhiz app.
- Follow the steps described in HomeWhiz Setup (HomeWhiz Setup) and proceed with the setup procedure.



Since the HomeWhiz Feature and Remote Control function on your appliance is operated via pairing using Bluetooth technology only one Homewhiz application can operate it at a time.

6.15.3 Deleting the HomeWhiz Account Match

Follow the following steps in order to delete a washing machine previously matched with someone else's account.

- Turn on your machine by using the On/Off button.
- When your machine is running, push and hold the Remote Control Function button and End Time Setting buttons for 5 seconds.

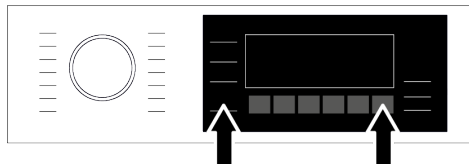

- You will hear warning sound from the product to notify your request after the countdown on the screen. Deleting the match will take a few seconds.

After this operation, you cannot use the HomeWhiz function of your washing machine until you do another setup.

Your product does not need to be connected to the internet in order to delete an account matching. Your request will be received. This matching will be automatically deleted when the product is first connected to the internet.

6.15.4 Remote Control Function and Using It

After HomeWhiz setup, bluetooth will automatically turn on. To activate or deactivate the Bluetooth connection, please see Bluetooth 3''.

If you turn off and on your machine while bluetooth is active, it will automatically reconnect. In cases such as paired device going off the range, bluetooth will automatically turn off. For this reason, you will need to turn on the bluetooth again if you want to use the Remote Control function.

You can check the bluetooth symbol on the display to track your connection status. If the symbol is continuously on, you have bluetooth connection. If the symbol is flashing, the product is trying to connect. If the symbol is off, you have no connection.



When the bluetooth connection is on in your product, Remote Control function will be selectable.

If the Remote Control function cannot be selected, check the connection status. If the connection cannot be established, repeat the initial setup steps over the product.

WARNING: For safety reasons, the product door will be locked and remain locked regardless of the operating mode of the product when the Remote Control function is activated. If you want to open the door of the product, you will need to turn the programme selection knob or press the remote control key to deactivate the remote control function.

When you want to control your washing machine remotely, after the front lid is closed, you need to activate the Remote Control function by pressing the Remote Control button while the programme knob is in the Download Programme/Remote Control position button on the control panel of your washing machine. Once access is established to the product, you will see a screen similar to the one below.

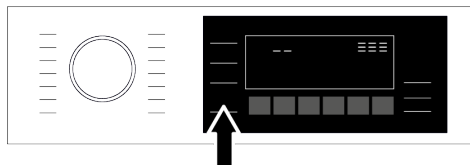

When the Remote Control is enabled, you can only manage the machine, turn it off and follow the status through your washing machine. And all functions except child lock can be managed through the application. You can follow whether the Remote Control function is On or Off through the function indicator on the button.

If the Remote Control function is Off, all the operations are handled on the washing machine and only status follow-up is allowed on the application.

In the event that Remote Start function cannot be turned on, appliance will make a warning sound when you press the button. This might happen in cases such as when the appliance is turned on and there is no paired smart device via bluetooth. Bluetooth settings being Off or the washing machine's door being open are examples for such cases.

Once you activate this function on the washing machine, it will remain enabled apart from certain conditions and allow you to control your washing machine remotely via bluetooth.

7 Maintenance and Cleaning



Please read the "Safety Instructions" section first!

In certain cases, it deactivates itself for safety reasons:

- When your washing machine undergoes a power interruption.
- When programme knob is turned and a different programme selected or appliance is turned off.

6.15.5 Troubleshooting

If you are having trouble on controlling or connecting, apply the following steps. Observe whether the problem persists or not after the action you have performed.

- a. Check whether your smart device is connected to the relevant home network.
- b. Restart the product application.
- c. Turn bluetooth off and then on via user control panel.
- d. If the connection cannot be established with the above processes, repeat the initial set-up settings on the washing machine.

If the problem persists, consult an Authorised Service Agent.

6.16 Drum Illumination

Drum illumination lamp of your machine will light up during programme selection. The lamp will go off 10 minutes after the programme starts. If no programme is started or no key is pressed within 10 minutes during programme selection process, the drum illumination lamp will go off.

Drum illumination lamp of your machine will light up after the programme is completed. It will go off when you turn off your machine with the Programme Selection Knob. The drum illumination lamp will go off if you do not press any button within 10 minutes after the programme has ended.

Service life of your product extends and frequently experienced problems will be reduced if it is cleaned at regular intervals.

7.1 Cleaning the Detergent Drawer

When to clean

- When you open the dosing tank cover and see a thickened non-fluid detergent or softener,
- If you are not satisfied with the washing results, it may be that the detergent or softener has become stiff and therefore cannot be taken into the washing area,
- If the liquid in the tank does not decrease although dosing is selected and you do not load detergents or softeners for a long time,
- If you want to change the washing ingredients you have filled in the chamber (for example, if you are not satisfied with the detergent and do not want to use it) or if you have done incorrect loading (for example, if you have placed detergent or softener in the detergent tank),
- If a different brand of detergent or softener will be added,
- If a washing agent with different specifications (e.g. if detergent is added for coloured ones when there is detergent in the tank for whites) is added,
- If a different-concentration washing agent is added (to avoid wasting the previously filled detergent, you can put them in the powder detergent compartment in the next washing and consume it by selecting the «powder detergent active» position on the screen.)
- If the new softener has the same specifications but only a different scent, (it should be noted that the scent of the mixture will be different if it is added without cleaning the remaining softener),
- If it is not going to be used for a long time (e.g. at the time of moving to the summer house and at the time of return, for 3 months or more), the liquid washing agent may become denser and may become stiffer at the end, and may not make dosing although the system indicates full.

Cleaning:

Before starting cleaning, unplug your appliance by pressing the On/Off button.

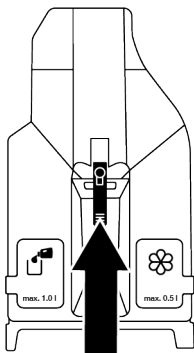
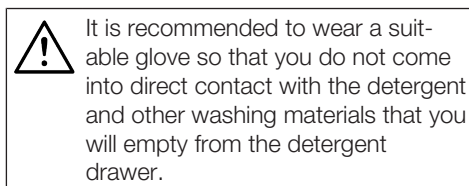

- a. Press the blue part in the middle of the detergent drawer to pull it towards you and remove it.

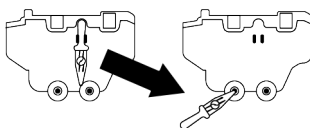

- b. Remove the drain stick located at the back of the drawer from its slot.
- c. Place the slot behind the detergent drawer to be emptied towards the inside of the compartment to be emptied.
- d. Gently push the drain stick into the slot behind the detergent compartment.
- e. The detergent will start to pour into the container.
- f. The same is carried out for the softener compartment.

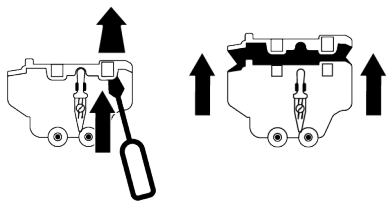

- g. The guides holding the top cover of the detergent drawer are removed with a flat-head screwdriver (there are total of 6 guides, two each on the right, left and back of the drawer) and the inside of the drawer is washed.
- h. After the completion of the washing process, the cover is inserted to the drawer. Make sure that all guides are in place. If the guides do not fit, liquid may spill from the drawer, or the detergent box may get trapped in the drawer rail or move in difficulty. Therefore, make sure that the guides are firmly seated.
- i. Insert the drain stick back into its slot in the back of the drawer.
- j. Refit the drawer by paying attention to its slot and slides and push the drawer to close. Once detergents and softeners are added, they will be ready for use in dosed programs.

7.2 Cleaning the Loading Door and the Drum

For products with drum cleaning programme, please see the Operating the product section.



Repeat Drum Cleaning process in every 2 months.

NOTICE: Use an anti-limescale suitable for the washing machines.

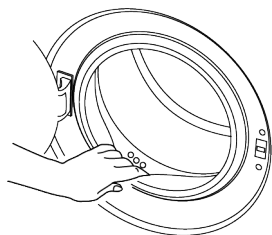

After every washing make sure that no foreign substance is left in the product.

If the holes on the door gasket shown in the figure is blocked, open the holes using a toothpick.

Foreign metal substances will cause rust stains in the drum. Clean the stains on the drum surface by using cleaning agents for stainless steel.

Never use steel wool or wire wool. These will damage the painted, chrome coated and plastic surfaces.

We recommend you to wipe the door gasket with a dry and clean cloth at the end of the programme. This will remove residues on the door gasket in your machine and prevent formation of malodours.

7.3 Cleaning the Body and Control Panel

Wipe the body of the product with soapy water or non-corrosive mild gel detergents as necessary, and dry with a soft cloth.

Use only a soft and damp cloth to clean the control panel. Do not use cleaning products that contain bleach

7.4 Cleaning the Water Intake Filters

There is a filter at the end of each water intake valve at the rear of the product and also at the end of each water intake hose where they are connected to the tap. These filters prevent foreign substances and dirt in the water to enter the product. Filters should be cleaned if they are dirty.

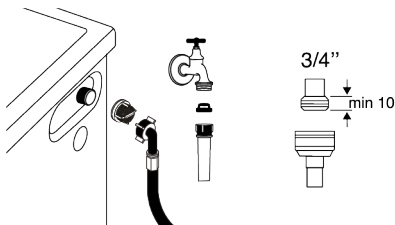

- a. Close the taps.
- b. Remove the nuts of the water intake hoses to access the filters on the water intake valves and clean them with an ap-

appropriate brush. If the filters are too dirty, remove them from their places with a pliers and clean in this way.

- c. Take out the filters on the flat ends of the water intake hoses together with the gaskets and clean thoroughly under running water.
- d. Replace the gaskets and filters carefully and tighten their nuts by hand.

7.5 Draining Remaining Water and Cleaning the Pump Filter

The filter system in your product prevents solid items such as buttons, coins and fabric fibres clogging the pump impeller during draining of washing water. Thus, the water will be drained without any problem and the service life of the pump will extend.

If the product fails to drain water inside it, the pump filter is clogged. Filter must be cleaned whenever it is clogged or in every 3 months. Water must be drained off first to clean the pump filter.

In addition, prior to transporting the product (e.g., when moving to another house) water should be drained completely.



NOTICE:

Foreign substances left in the pump filter may damage your product or may cause noise problem.

In regions where freezing is possible, the tap must be closed, system hose must be removed and the water inside the product must be drained when the product is not in use.

After each use, turn off the tap to which the mains hose is connected.

In order to clean the dirty filter and drain the water:

- a. Unplug the product to cut off the supply power.



Temperature of the water inside the product may rise up to 90 °C. To avoid the risk of scalding, clean the filter after the water inside the product is cooled down.

- b. Open the filter cover.

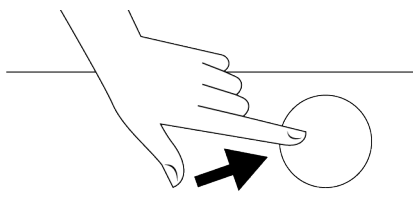

- c. Follow the below procedures in order to drain water.

If the product has an emergency water draining hose, in order to drain the water:

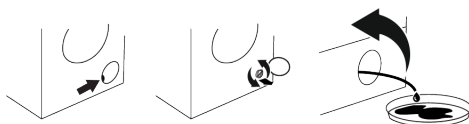

- Pull the emergency draining hose out of its seat.
 - Place the end of the hose in a large container. Drain the water into the container by pulling out the plug at the end of the hose. When the container is filled, close the end of the hose with the plug. Drain all water by repeating the procedure specified above after draining the container.
 - When the water drain is finished, close the end with the plug again and fix the hose in its place.
 - Unscrew the pump filter.
- a. Clean any residues inside the filter as well as fibres, if any, around the pump impeller region.
 - b. Replace the filter.
 - c. If the filter cap is composed of two pieces, close the filter cap by pressing on the tab. If it is one piece, seat the tabs in the lower part into their places first, and then press the upper part to close.

8 Troubleshooting



Please read the "Safety Instructions" section first!

Programmes do not start after the loading door is closed.

- Start / Pause / Cancel button might not be pressed. >>> * Press the Start / Pause / Cancel button.
- It may be difficult to close the loading door in case of excessive loading. >>> Reduce the amount of laundry and make sure that the loading door is closed properly.

Programme cannot be started or selected.

- The product has switched to self-protection mode due to a supply problem (line voltage, water pressure, etc.). >>> Depending on the product model, select another program by turning the Program Selection button or pressing and holding the On/Off button for 3 seconds to cancel the program. Previous programme will be cancelled. See Cancelling the Programme

Water inside the product.

- Some water has remained in the product due to the quality control processes in the production. >>> This is not a failure; water is not harmful to the product.

The product does not take water in.

- Tap is turned off. >>> Turn on the taps.
- Water inlet hose is bent. >>> Flatten the hose.
- Water inlet filter is clogged. >>> Clean the filter.
- Loading door is not closed. >>> Close the door.

The product does not drain water.

- Water drain hose is clogged or twisted. >>> Clean or flatten the hose.
- Pump filter is clogged. >>> Clean the pump filter.

Product vibrates or makes noise.

- Product is standing unbalanced. >>> Adjust the stands to balance the product.

- A hard substance has entered into the pump filter. >>> Clean the pump filter.
- Transportation safety bolts are not removed. >>> Remove the transportation safety bolts.
- Laundry quantity in the product is too little. >>> Add more laundry to the product.
- Excessive laundry is loaded in the product. >>> Take out some of the laundry from the product or distribute the load by hand to balance it homogeneously in the product.
- Product is leaning on a rigid item. >>> Make sure that the product is not leaning on anything.

There is water leaking from the bottom of the product.

- Water drain hose is clogged or twisted. >>> Clean or flatten the hose.
- Pump filter is clogged. >>> Clean the pump filter.

Product stopped shortly after the programme started.

- Machine has stopped temporarily due to low voltage. >>> Product will resume running when the voltage restores to the normal level.

Product directly drains the water it takes in.

- Draining hose is not at adequate height. >>> Connect the water draining hose as described in the user manual.

No water can be seen in the product during washing.

- Water is inside the invisible part of the product. >>> This is not a failure.

Loading door cannot be opened.

- Loading door lock is activated because of the water level in the product. >>> Drain the water by running the Pump or Spin programme.
- Product is heating up the water or it is at the spinning cycle. >>> Wait until the programme completes.

- Loading door may be stuck because of the pressure it is subjected to. >>> Grab the handle and push and pull the loading door to release and open it.
- If there is no power, loading door of the product will not open. >>> To open the loading door, open the pump filter cap and pull down the emergency handle positioned at the rear side of the said cap. See Loading Door Lock [▶ 32]

Washing takes longer than specified in the user manual. (*)

- Water pressure is low. >>> Product waits until taking in adequate amount of water to prevent poor washing quality due to the decreased amount of water. Therefore, the washing time extends.
- Voltage is low. >>> Washing time is prolonged to avoid poor washing results when the supply voltage is low.
- Input temperature of water is low. >>> Required time to heat up the water extends in cold seasons. Also, washing time can be lengthened to avoid poor washing results.
- Number of rinses and/or amount of rinsing water have increased. >>> Product increases the amount of rinsing water when good rinsing is needed and adds an extra rinsing step if necessary.
- Excessive foam has occurred and automatic foam absorption system has been activated due to too much detergent usage. >>> Use recommended amount of detergent.

Programme duration does not countdown. (On models with display) (*)

- Timer may stop during water intake. >>> Timer indicator will not countdown until the product takes in adequate amount of water. The product will wait until there is sufficient amount of water to avoid poor washing results due to lack of water. Timer indicator will resume countdown after this.
- Timer may stop during heating step. >>> Timer indicator will not countdown until the product reaches the selected temperature.

- Timer may stop during spinning step. >>> Automatic unbalanced load detection system is activated due to the unbalanced distribution of the laundry in the product.

Programme duration does not countdown. (*)

- There is unbalanced load in the product. >>> Automatic unbalanced load detection system is activated due to the unbalanced distribution of the laundry in the product.

Product does not switch to spinning step. (*)

- There is unbalanced load in the product. >>> Automatic unbalanced load detection system is activated due to the unbalanced distribution of the laundry in the product.
- The product will not spin if water is not drained completely. >>> Check the filter and the draining hose.
- Excessive foam has occurred and automatic foam absorption system has been activated due to too much detergent usage. >>> Use recommended amount of detergent.

Washing performance is poor: Laundry turns gray. ()**

- Insufficient amount of detergent has been used over a long period of time. >>> Use the recommended amount of detergent appropriate for water hardness and the laundry.
- Washing has been made at low temperatures for a long time. >>> Select the proper temperature for the laundry to be washed.
- Insufficient amount of detergent is used with hard water. >>> Using insufficient amount of detergent with hard water causes the soil to stick on the cloth and this turns the cloth into gray in time. It is difficult to eliminate graying once it happens. Use the recommended amount of detergent appropriate for water hardness and the laundry.
- Excessive amount of detergent is used. >>> Use the recommended amount of detergent appropriate for water hardness and the laundry.

Washing performance is poor: Stains persist or the laundry is not whitened. ()**

- Insufficient amount of detergent is used. >>> Use the recommended amount of detergent appropriate for water hardness and the laundry.
- Excessive laundry is loaded in. >>> Do not load the product in excess. Load with amounts recommended in the "Programme and consumption table".
- Wrong programme and temperature were selected. >>> Select the proper programme and temperature for the laundry to be washed.
- Wrong type of detergent is used. >>> Use original detergent appropriate for the product.
- Excessive amount of detergent is used. >>> Put the detergent in the correct compartment. Do not mix the bleaching agent and the detergent with each other.

Washing performance is poor: Oily stains appeared on the laundry. ()**

- Regular drum cleaning is not applied. >>> Clean the drum regularly. For this procedure, see Cleaning the Loading Door and the Drum [► 39]

Washing performance is poor: Clothes smell unpleasantly. ()**

- Odours and bacteria layers are formed on the drum as a result of continuous washing at lower temperatures and/or in short programmes. >>> Leave the detergent drawer as well as the loading door of the product ajar after each washing. Thus, a humid environment favourable for bacteria cannot occur in the machine

Colour of the clothes faded. ()**

- Excessive laundry was loaded in. >>> Do not load the product in excess.
- Detergent in use is damp. >>> Keep detergents closed in an environment free of humidity and do not expose them to excessive temperatures.

- A higher temperature was selected. >>> Select the proper programme and temperature according to the type and soiling degree of the laundry.

Washing machine does not rinse well.

- The amount, brand and storage conditions of the detergent used are inappropriate. >>> Use a detergent appropriate for the washing machine and your laundry. Keep detergents closed in an environment free of humidity and do not expose them to excessive temperatures.
- Detergent was put in the wrong compartment. >>> If detergent is put in the pre-wash compartment although prewash cycle is not selected, the product can take this detergent during rinsing or softener step. Put the detergent in the correct compartment.
- Pump filter is clogged. >>> Check the filter.
- Draining hose is folded. >>> Check the drain hose.

Laundry became stiff after washing. ()**

- Insufficient amount of detergent is used. >>> Using insufficient amount of detergent for the water hardness can cause the laundry to become stiff in time. Use appropriate amount of detergent according to the water hardness.
- Detergent was put in the wrong compartment. >>> If detergent is put in the pre-wash compartment although prewash cycle is not selected, the product can take this detergent during rinsing or softener step. Put the detergent in the correct compartment.
- Detergent was mixed with the softener. >>> Do not mix the softener with detergent. Wash and clean the drawer with hot water.

Laundry does not smell like the softener. ()**

- Detergent was put in the wrong compartment. >>> If detergent is put in the pre-wash compartment although prewash cycle is not selected product, the can take this detergent during rinsing or softener

step. Wash and clean the drawer with hot water. Put the detergent in the correct compartment.

- Detergent was mixed with the softener. >>> Do not mix the softener with detergent. Wash and clean the drawer with hot water.
- Softener dosage setting may be in low level. >>> Increase the softener dosage amount by one level. See "Automatic Dosage Setting".

Detergent residue in the detergent drawer. ()**

- Detergent was put in wet drawer. >>> Dry the detergent drawer before putting in detergent.
- Detergent has gotten damp. >>> Keep detergents closed in an environment free of humidity and do not expose them to excessive temperatures.
- Water pressure is low. >>> Check the water pressure.
- The detergent in the main wash compartment got wet while taking in the prewash water. Holes of the detergent compartment are blocked. >>> Check the holes and clean if they are clogged.
- There is a problem with the detergent drawer valves. >>> Call the Authorised Service Agent.
- Detergent was mixed with the softener. >>> Do not mix the softener with detergent. Wash and clean the drawer with hot water.
- Regular drum cleaning is not applied. >>> Clean the drum regularly. For this procedure, see Cleaning the Loading Door and the Drum [► 39]

Too much foam forms inside the product. ()**

- Improper detergents for the washing machine is used. >>> Use detergents appropriate for the washing machine.
- Excessive amount of detergent is used. >>> Use only sufficient amount of detergent.

- Detergent was stored under improper conditions. >>> Store detergent in a closed and dry location. Do not store in excessively hot places.
- Some meshed laundry such as tulle may foam too much because of their texture. >>> Use smaller amounts of detergent for this type of item.
- Detergent was put in the wrong compartment. >>> Make sure you place the detergent in the appropriate compartment.

Foam is overflowing from the detergent drawer.

- Too much detergent is used. >>> Mix 1 tablespoonful softener and ½ l water and pour into the main wash compartment of the detergent drawer. >>> Put detergent into the product suitable for the programmes and maximum loads indicated in the "Programme and consumption table". When you use additional chemicals (stain removers, bleaches and etc.), reduce the amount of detergent.

Laundry remains wet at the end of the programme. (*)

- Excessive foam has occurred and automatic foam absorption system has been activated due to too much detergent usage. >>> Use recommended amount of detergent.

(*) The product does not switch to spinning step when the laundry is not evenly distributed in the drum to prevent any damage to the product and to its surrounding environment. Laundry should be rearranged and respun.

(**) Regular drum cleaning is not applied. Clean the drum regularly. See Cleaning the Loading Door and the Drum [► 39]



If you cannot eliminate the problem although you follow the instructions in this section, consult your dealer or the Authorised Service Agent. Never try to repair a nonfunctional product yourself.



Check the HomeWhiz section for the relevant troubleshooting information.

Warranty

This certificate is issued by DEFY APPLIANCES (PTY) LIMITED manufacturers and suppliers of Grundig products, hereinafter the Company, to the original purchaser only, of the appliance described on the certificate and shall constitute the only warranty given in respect of this appliance.

The Company warrants to the original purchaser that for a period of FIVE YEARS from date of purchase the appliance is free from defect under normal domestic use, both in workmanship and material, subject to the following conditions.

1. Repair or replacement of any part of this appliance, found by the Company to be defective, shall be at the election of the Company. The Company reserves the right to effect such service through any of its Service Divisions or Authorised Service Dealers. The cost of such service shall be borne by the Company in full, provided that the appliance is located no further than 50km from a Company Service Centre or an Authorised Service Dealer. Where the appliance is located beyond the 50km radius, the purchaser shall be liable for the standard travelling charges, as determined by the Company.
2. Vitreous enamelware, fuses and lamps are specifically excluded from these warranties. It is an express condition of these warranties that the purchaser takes due care and attention in the use and maintenance of the appliance. Abuse, misuse in conflict with operating instructions, connection to incorrect voltages and subjection to commercial use shall release the Company from its obligations.
3. This warranty shall become void and cease to operate if the appliance is dismantled by, or any repairs to the appliance are effected by any persons not duly authorised by the Company, or if substitute parts not approved by the Company are used in the appliance, or if the serial number of the appliance is removed.
4. The Company shall not be responsible for damages resulting from fire, flood, civil disturbances or any Act of God. The Company shall not, in terms of these warranties be responsible nor held liable for any consequential loss or damage of any kind caused by or due to the failure or malfunction of the appliance.
5. The Company shall not be responsible for transportation or other costs other than those incurred within the provisions of Point 1 of this Certificate.
6. **For warranties in the Republic of South Africa and Sub-Saharan Africa, please contact the Grundig customer help line listed on the previous page for service or any other queries.**
7. Where service is requested under warranty and no fault or defect can be found by the Company, all costs incurred will be for the purchaser's account.
8. This Certificate as well as your invoice will serve as proof of purchase. For the purpose of warranty, it will be essential to produce this Certificate and invoice. Failure to do so, will render the purchaser liable for service costs.

KEEP THIS CERTIFICATE AND SALES INVOICE AS PROOF OF PURCHASE FOR WARRANTY PURPOSES.

Service Centres

Before requesting service please check the trouble-shooting guide in the Operating Instructions as a charge may be levied where no fault is found even though your product may still be under guarantee.

Please contact the Grundig Customer help-line for service or any other queries on 0861 478634

