

# DOUBLE OVEN

## USER INSTRUCTIONS

GEDM26000B

<http://southafrica.grundig.com>  
PART No: 069755

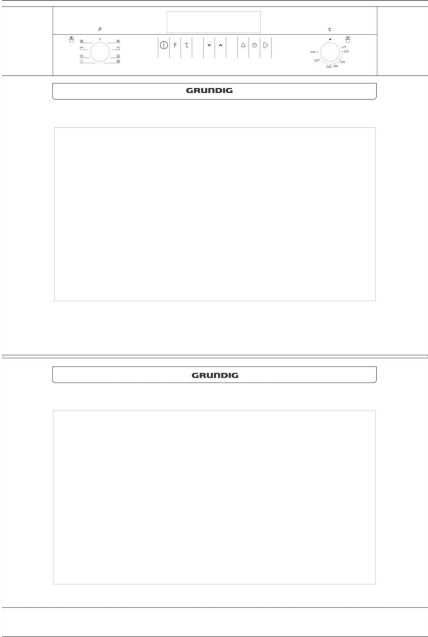

FOR A GOOD REASON

**GRUNDIG**

Please read this user manual first!

Dear Customer,

Thank you for purchasing this Grundig product. We hope that you get the best results from your product which has been manufactured with high quality and state-of-the-art technology. Therefore, please read this entire user manual and all other accompanying documents carefully before using the product and keep it as a reference for future use. If you handover the product to someone else, give the user manual as well. Follow all warnings and information in the user manual. Remember that this user manual is also applicable for several other models. Differences between models will be identified in the manual.

## Explanation of symbols used in this manual



Important safety information. Warning for hazardous situations with regard to life and property.



Caution; Warning for supply voltage.



Caution; Warning for fire hazard.



Useful information. Important information or useful hints about usage.

## Contents

<b><u>1. Important Safety Instructions</u></b>	<b><u>3</u></b>	<b><u>4. How to use the oven</u></b>	<b><u>14</u></b>
General safety	3	General information about baking, roasting and grilling	14
Electrical safety	3	Operating modes	16
Appliance safety	4	How to operate the oven control unit	17
Safety when working with electricity	5	How to operate the oven	18
Intended use	6	Activating the keylock	20
Safety for children	6	Setting the alarm clock	20
		Changing the time of day	21
<b><u>2. General information</u></b>	<b><u>7</u></b>	Cooking times table	22
Overview	7	How to operate the grill	24
Package contents	8		
Technical Specifications	9		
		<b><u>5. Maintenance and care</u></b>	<b><u>25</u></b>
<b><u>3. Installation</u></b>	<b><u>10</u></b>	General information	25
Before installation	10	Cleaning the oven	25
Oven Installation	11	Removing the door inner glass	25
Installation and connection	11	Replacing the oven light bulb	26
Initial use	12		
Time setting	12	<b><u>6. Trouble Shooting</u></b>	<b><u>27</u></b>
First cleaning of the appliance	13		
Initial heating	13	<b><u>7. Grundig help line</u></b>	<b><u>27</u></b>
		<b><u>8. Warranty</u></b>	<b><u>28</u></b>



PART NO: 3815010100

**Customer Care Line**

(after sales service)

**086 147 8634**

FOR A GOOD REASON

**GRUNDIG**

## 1. Important safety instructions

---

This section contains safety instructions that will help you avoid risk of injury and damage. All warranties will become void if you do not follow these instructions.

### **General safety**

- This appliance is not intended for use by persons (including children) with reduced physical, sensory or mental capabilities or lack of experience and knowledge, unless they have been given supervision or instruction concerning the use of the appliance by a person responsible for their safety.
- Children must be supervised to prevent them from tampering with the appliance.
- Installation and repair procedures must always be performed by authorized service agents.
- Do not operate the appliance if it is defective or has any visible damage.

- The manufacturer shall not be held responsible for damages arising from procedures carried out by unauthorized persons which may also void the warranty. Before installation read the instructions carefully.
- Make sure that the appliance function controls are switched off after every use.

### **Electrical safety**

- If the appliance has a failure, it should not be operated unless it is repaired by an authorized service agent. There is a risk of an electric shock!
- Connect the appliance to an earthed outlet/line protected by a fuse of suitable capacity. Have the earth installation made by a qualified electrician. This appliance must be earthed and the manufacturer and the seller do not accept responsibility for any damage due to incorrect installation or electrical connection.

- Never wash down the appliance with water! There is the risk of electric shock!
  - The appliance must be disconnected from the mains during installation, maintenance, cleaning and repair procedures.
  - If the supply cord is damaged, it must be replaced by the manufacturer, its service agent or similarly qualified persons in order to avoid a hazard.
  - The appliance must be installed so that it can be completely disconnected from the network. The separation must be provided either by a mains plug, or a switch built into the fixed electrical installation according to construction regulations.
  - The rear surface of the oven gets hot when it is in use. Ensure that the electrical connection does not come into contact with the rear surface so as not to damage connections.
  - Ensure that the appliance is switched off before replacing the lamp to avoid the possibility of electric shock.
  - Only use the temperature probe recommended for this oven.
  - Do not trap the mains cable between the oven door and frame and do not route it over hot surfaces as the cable insulation may melt and cause a fire as a result of a short circuit.
  - Any work on electrical equipment and systems should only be carried out by authorized and qualified persons.
  - In case of any damage, switch off the appliance and disconnect it from the mains. To do this, switch off the circuit breaker at the wall.
  - Ensure that the fuse rating is compatible with the appliance.
- Appliance safety**
- The appliance and its accessible parts become hot during use. Care should be taken to avoid touching heating elements inside the oven. Children must be kept away unless continually supervised.
  - Never use the appliance when your judgment or coordination is impaired by the use of alcohol and/or drugs.

- Be careful when using alcoholic drinks in your dishes. Alcohol evaporates at high temperatures and may cause fire since it can ignite when it comes into contact with hot surfaces.
  - Do not place any flammable materials close to the appliance as the sides may become hot during use.
  - Keep all ventilation slots clear of obstructions.
  - Do not heat closed tins and glass jars in the oven. The pressure that would build-up in the tin/jar may cause the tin/jar to burst.
  - Do not place baking trays, dishes or aluminium foil directly onto the bottom of oven. Heat accumulation may damage the bottom of the oven.
  - Do not use harsh abrasive cleaners or sharp metal scrapers to clean the oven door glass as these may scratch the glass surface.
  - Do not use steam cleaners to clean the appliance as this may cause an electric shock.
  - Use the shelves as described in “How to operate the electric oven”
  - Do not use the appliance if the front door glass has been removed or is cracked.
  - Always use heat resistant oven gloves when putting in or removing dishes into/from the hot oven.
  - Ensure the appliance is switched off before replacing the lamp to avoid the possibility of an electric shock.
  - Do not carry out any repairs or modifications on the appliance.
  - To prevent a fire hazard
  - Ensure the plug fits into the socket well so as not to cause a spark.
  - Do not extend or cut the power cable. Use only an original power cable. Do not use a damaged power cable.
  - Ensure that there is no liquid or moisture on the socket where the appliance is plugged in.
- Safety when working with electricity**
- Defective electric equipment is one of the major causes of house fires.
  - Make sure that the fuse rating is compatible with the appliance.

- Any work on electrical equipment and systems should only be carried out by authorized and qualified persons. If the appliance is damaged in any way, do not use it. Report the damage to your dealer, who will take the necessary corrective action.

### **Intended use**

- The appliance must only be used for domestic use and for the purposes for which it was designed. Commercial use will void the guarantee. This appliance is for cooking purposes only. It must not be used for other purposes, for example room heating.
- Do not use the appliance for warming plates under the grill, drying towels, dish cloths or similar textile products by hanging them on the oven door handle.
- The manufacturer shall not be liable for any damage caused by improper use or handling errors.
- The oven can be used for defrosting, baking, roasting and grilling food.

### **Safety for children**

- Electrical appliances are dangerous to children. Keep children away from the appliance when it is operating and do not allow them to play with the appliance.
- Accessible parts of the appliance will become hot whilst the appliance is in use. Children should be kept away until the appliance has cooled down
- Do not place any items above the appliance that children may reach for.
- Please ensure that packaging material is disposed of in a responsible manner. Plastic bags should be cut up to prevent children playing with them and accidentally suffocating.
- When the oven door is open do not load any heavy objects on it and do not allow children to sit on it. The appliance may overturn or the door hinges may be damaged.
- Some models feature a protective film over stainless steel trim. This film must be carefully removed before using the appliance.

### **SAVE THESE INSTRUCTIONS**

## 2. General Information

### Overview

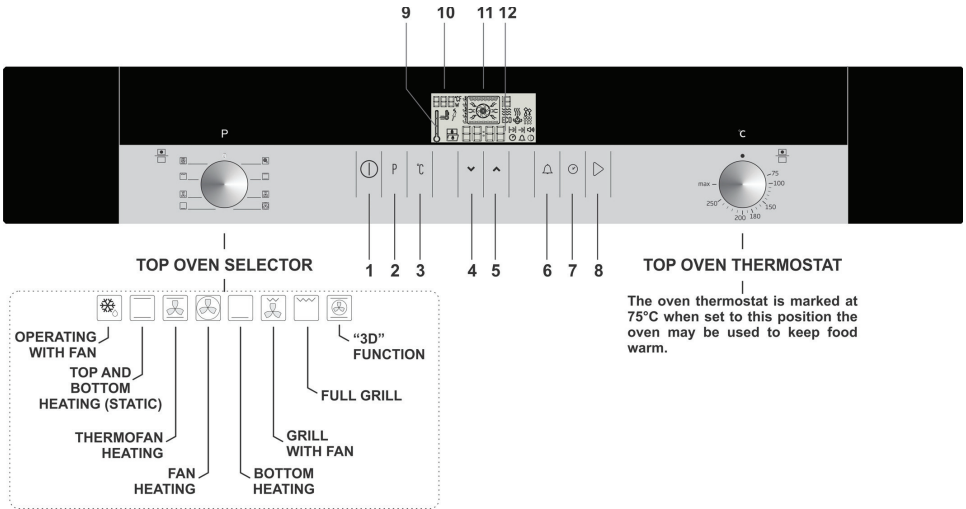

- 1 ON/OFF key
- 2 Return key to function display
- 3 Temperature setting key
- 4 Minus key
- 5 Plus key
- 6 Alarm key

- 7 Adjustment key
- 8 Start/stop cooking key
- 9 Oven inner temperature symbol
- 10 Temperature indicator field
- 11 Function display
- 12 Current time indicator field

	<p><b>Unpacking:</b> Remove all packaging. Ensure that packing material is disposed of in a responsible manner and that any plastic bags are cut up to prevent children playing with them and accidentally suffocating.</p> <p>If the appliance is damaged in any way do not use it. Report the damage to your dealer who will take the necessary corrective action.</p>
	<p>The manufacturer strives for continuous improvement. For this reason, the text and illustrations in this manual are subject to change without notice.</p> <p>Figures in this manual are schematic and may not exactly match your appliance.</p>

## Package contents



Accessories supplied may vary depending on the product model. Not every accessory described in the user manual may exist on your product.

### 1. User manual

### 2. Oven tray

Used for pastries, frozen foods and big roasts.

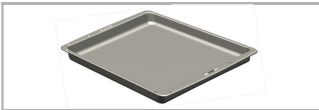

### 3. Deep tray

Used for pastries, large roasts, juicy dishes, and for collecting fat while grilling.



### 4. Wire Shelf

Used for roasting and for placing food to be baked, roasted or cooked in casserole dishes on to the desired rack.



### 5. Placing the wire shelf and tray onto the telescopic racks properly

It is important to place the wire shelf and/or tray onto the rack properly. Telescopic racks allow you to install and remove the trays and wire shelf easily. When using the tray and wire shelf with telescopic racks, ensure that the pins at the rear section of the telescopic rack stand against the edges of the wire shelf and tray.

For non telescopic racks, slide the wire shelf or tray between 2 rails and make sure that it is fitted properly before placing food on it (Please see the following figure).

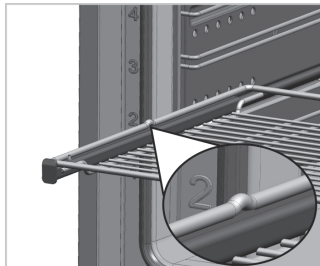
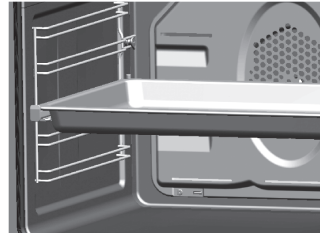
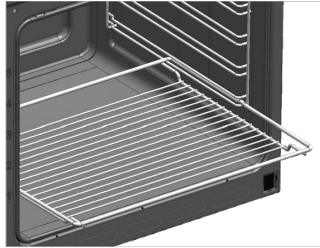

### 6. Meat probe

When cooking meat dishes, it is used by stabbing the thin long end into the meat and attaching the other end to its slot on the side wall of the chassis in order to cook the dish delicately.

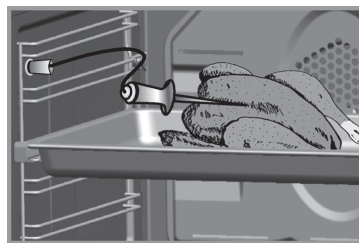







Technical Specifications	
Voltage / frequency	220-240V~ 50 Hz
Maximum power consumption	5.98 kW
Amperage	26 A
External dimensions (height / width / depth)	1090 x 730 x 580
Installation dimensions (height / width / depth)	Refer to page 11
Main oven	<b>Multifunction oven</b>
Energy efficiency class*	-
Inner lamp	4 x 25W
Grill power consumption	<b>2.2 kW</b>





\* Basics: Information on the energy label of electrical ovens is given in accordance with the SANS 50304 standard. Those values are determined under standard load with bottom-top heater or fan assisted heating (if any) functions.

The energy efficiency class is determined according to function: Cooking with eco-fan

\*\* See Installation.

	<b>DANGER</b>
	Risk of scalding by hot steam!
	Take care when opening the oven door as steam may escape.

	<b>WARNING</b> Hot surfaces may cause burns! Do not touch the hot surfaces of the appliance. Use oven gloves. Keep children away from the appliance.
	
	<b>DANGER</b> Risk of fire by overheated oil! When heating oil, do not leave it unattended. Never try to extinguish a fire with water! When oil has caught fire, immediately cover the pot or pan with a lid. Switch off the hob if safe to do so and phone the fire service.



	<b>WARNING: Under no circumstances should the bake element be covered with aluminium foil. Nor should a pan or tray be positioned directly above the bake element.</b>	
		

	Figures in this manual are schematic and may not exactly match your appliance.
	Values stated on the appliance labels or in the documentation accompanying it are obtained in laboratory conditions in accordance with relevant standards. Depending on operational and environmental conditions of the appliance, these values may vary.

### 3. Installation

---

The appliance must be installed by a qualified person in accordance with the regulations in force with all local gas and electrical regulations. Installation is the buyer's responsibility. The manufacturer accepts no liability for this service. Any action that the manufacturer has to take as a result of an erroneous installation will not be covered by the warranty.

	<b>Preparation of location and electrical and gas installation for the appliance is the customer's responsibility.</b>
	<b>DANGER:</b> The appliance must be installed in accordance with all local gas and/or electrical regulations.
	<b>DANGER:</b> Prior to installation, visually check if the appliance has any defects on it. If so, do not have it installed. Damaged appliances cause risks for your safety.

#### Before installation

The appliance is intended for installation in commercially available kitchen cabinets. A safety distance must be left between the appliance and the kitchen walls and furniture. See figures on following page: "Built in oven cut outs" (values in mm).

Cooking appliances generate considerable heat. The layout and materials of the mounting cabinet should take account of these characteristics.

- Surfaces, surrounding edges, synthetic laminates and adhesives immediately adjacent to the appliance should be able to withstand temperatures of up to 100°C without delaminating or discolouring.
- Kitchen cabinets must be set level and fixed.
- If there is a drawer beneath the oven, a shelf must be installed between the oven and drawer.
- Carry the appliance with at least two persons.

	Do not install the appliance next to refrigerators or freezers. The heat emitted by the appliance will lead to an increased energy consumption of cooling products.
	The door and/or handle must not be used for lifting or moving the appliance.
	Do not place any objects onto the appliance and move it in upright position.
	Check the general appearance of your appliance for any damages that might have occurred during transportation.

## Oven installation

- Insert the oven into the cupboard.
- Open the door to expose the fixing holes in the side trims.
- Secure the oven by 4 countersunk screws (fasteners are not supplied).

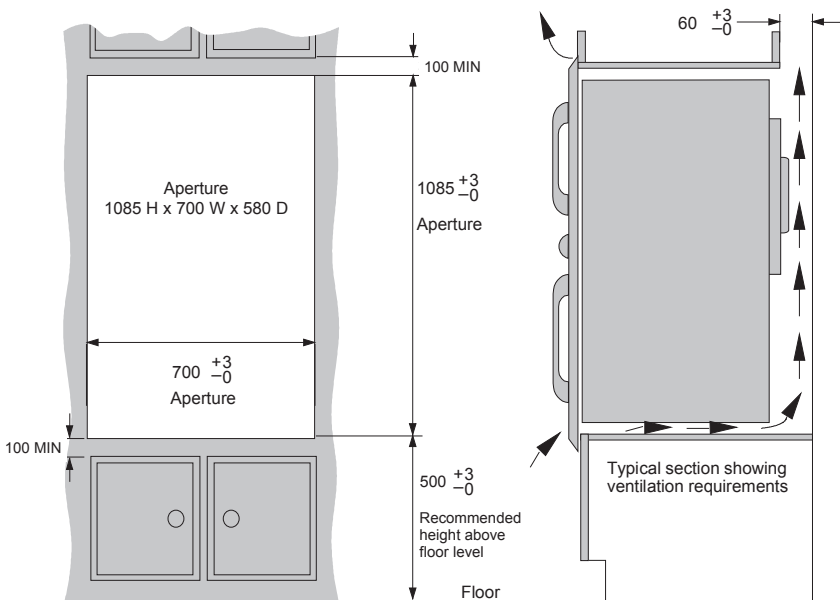

- Support the oven in front of the aperture and make the electrical connection before installing. This will ensure enough cable length for subsequent servicing.
- Slide the oven fully into the cabinet before securing it.
- Fixing holes are located on the side trims. Secure the oven by inserting small wood screws through these holes into the cabinet side wall. (screws are not provided).
- It is adequate to only secure the unit on one side. (same side as the handle).

## Installation and connection

The appliance must be installed in accordance with all local gas and electrical regulations.

## Electrical installation

This appliance must be earthed and the manufacturer and the seller do not accept responsibility for any damage due to incorrect installation or electrical connection.



This appliance should not be connected through an earth leakage system. Refer to S.A.N.S.10142.

## Connection to the power supply

The connection must be carried out by a licensed electrician, who will ensure that the oven is correctly connected and safely earthed. The rated current is printed on the serial number label attached to the oven side trim.

The appliance must be connected to the mains through a double pole isolating switch which has a minimum clearance between the contacts of 3 mm. in both poles.

A means for disconnection must be provided in the fixed wiring.

	<p><b>DANGER:</b> The appliance must be connected to the mains supply only by authorised and qualified persons. The appliances warranty period starts only after correct installation. The manufacturer shall not be held responsible for damages arising from procedures carried out by unauthorised persons.</p>
	<p><b>DANGER:</b> Risk of electric shock, short circuit or fire by damage of the mains lead! The mains lead must not be clamped, bent or trapped or come into contact with hot parts of the oven. If the mains lead is damaged, it must be replaced by a qualified electrician.</p>
	<p><b>DANGER:</b> Risk of electric shock! Before starting any work on the electrical installation, please disconnect the appliance from the mains supply.</p>

Place the plastic/metal saddle around the sprague and fasten via the 2 self tapping screws onto the factory pre punched holes on the back of the stove.

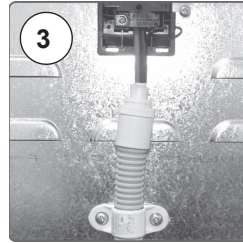

### Connecting the sprague to the oven

	<p><b>WARNING! ELECTRICAL CONNECTION MUST ONLY BE DONE BY A QUALIFIED ELECTRICIAN!</b></p>
---	--

Purchase a standard plastic/metal saddle type bracket, capable of going around the 20 mm diameter sprague and with a hole pitch of 38 mm (Plastic) 45 mm (Metal), from your local hardware and 2 off 4.2 mm x 12 mm self tapping screws.

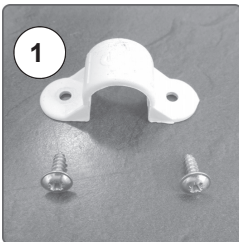



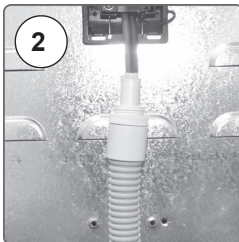



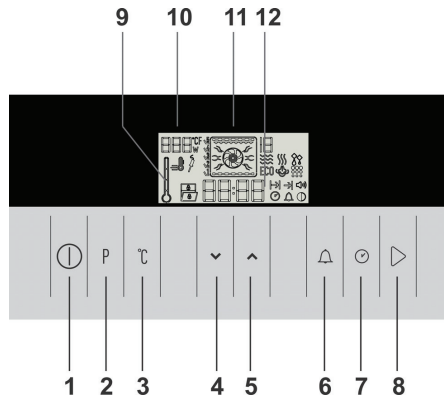



Connect the cabling onto the stove connector.









### Initial use Time setting



- 1 ON/OFF key
- 2 Return key to function display
- 3 Temperature setting key
- 4 Minus key
- 5 Plus key
- 6 Alarm key
- 7 Adjustment key
- 8 Start/stop cooking key
- 9 Oven inner temperature symbol
- 10 Temperature indicator field
- 11 Function display
- 12 Current time indicator field

-  Cooking Time symbol
-  End of Cooking Time symbol
-  Function symbol
-  Alarm symbol
-  Clock symbol
-  Keylock symbol
-  Open door symbol
-  Booster symbol (rapid pre-heating)
-  Meat Probe symbol
-  Cooking pause symbol
-  Cooking starting symbol

1. At the initial operation of the oven  symbol lights up, touch  /  keys to set the hour.
2. Confirm the setting by touching  symbol and wait for 4 seconds without touching any keys to confirm.

 If the current time is not set, time indicator will start increasing/moving up from **12:00**.  symbol will be activated to indicate that the current time has not been set. It will disappear as soon as the time is set.

### First cleaning of the appliance

 Surfaces might get damaged by some detergents or cleaning materials. Do not use aggressive detergents, cleaning powders/creams or any sharp objects during cleaning. Do not use harsh abrasive cleaners or sharp metal scrapers to clean the oven door glass since they can scratch the surface, which may result in the glass shattering.

1. Remove all packaging materials.
2. Wipe the surfaces of the appliance with a damp cloth or sponge and dry with a cloth.

### Initial heating

Heat up the appliance for about 30 minutes and then switch it off. Thus, any production residues or layers will be burnt off and removed.

 **WARNING**  
Hot surfaces cause burns!  
The appliance may be hot when it is in use. Never touch the inner sections of the oven, heaters etc. Keep children away. Always use heat resistant oven gloves when placing or removing dishes into/from the hot oven.

### Electric oven

1. Take all baking trays and the wire shelves out of the oven.
2. Close the oven door.
3. Select Static position.
4. Select the highest grill power; (See section on how to operate the electric oven).
5. Operate the oven for about 30 minutes.
6. Turn off your oven; (See section on how to operate the electric oven).

### Grill oven

1. Take baking trays and wire shelves out of the oven.
2. Close the oven door.
3. Select the highest grill power; (See section on how to operate the grill).
4. Operate the grill about 30 minutes.
5. Turn off your grill; (See section on how to operate the grill).

 Smoke and smell may emit for a couple of hours during the initial operation. This is quite normal. Ensure that the room is well ventilated to remove the smoke and smell. Avoid directly inhaling the smoke and the smell that emits.

**Final check:** Check the functions.

### For appliances with a cooling fan

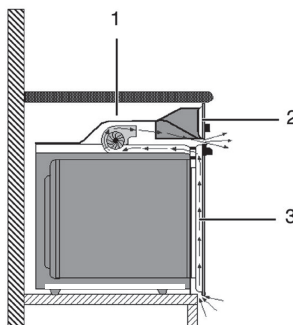

The built-in cooling fan cools both the built-in cabinet and the front of the appliance.

- 1 Cooling fan
- 2 Control panel
- 3 Door

 Please note that the cooling fan may continue to run well after the oven has been switched off. The duration is dependent on the selected operating temperature. This is a built-in safety feature to ensure that your oven is cooled down correctly. To reduce the cooling fan running time, the oven door may be left ajar after the oven has been switched off. Please be cautious of hot surfaces.

## 4. How to use the oven

### General information on baking, roasting and grilling

	<b>WARNING</b> Hot surfaces cause burns! Product may be hot when it is in use. Never touch the hot burners, inner sections of the oven, heaters and etc. Keep children away. Always use heat resistant oven gloves when putting in or removing dishes into/ from the hot oven.
	<b>DANGER:</b> Be careful when opening the oven door as steam may escape. Exiting steam can scald your hands, face and/or eyes

#### Tips for baking

Use non-sticky coated appropriate metal plates or aluminum vessels or heat-resistant silicone moulds. Make best use of the embossed shelf runners. Place the baking mould in the middle of the shelf. Select the correct embossed shelf runner position before turning the oven or grill on. Do not change the shelf position when the oven is hot. Keep the oven door closed.

#### Tips for roasting

Treating whole chicken, turkey and large pieces of meat with dressings such as lemon juice and black pepper before cooking will increase the cooking performance.



It takes about 15 to 30 minutes longer to roast meat with bones when compared to roasting the same size of meat without bones. Each centimeter of meat thickness requires approximately 4 to 5 minutes of cooking time. Leave meat in the oven for about 10 minutes after the cooking time is over. The juice is better distributed all over the roast and does not run out when the meat is cut.

	<b>Warning:</b> Do not put metal items such as forks, knives or saucepan covers into your oven since they can get very hot.
--	---

Fish should be placed on the middle or lower shelf in a heat-resistant plate.

#### Tips for grilling

When meat, fish and poultry are grilled, they quickly brown, develop a crust and do not dry out quickly. Flat pieces, meat skewers and sausages are particularly suited for grilling as are vegetables with high water content such as tomatoes and onions. Distribute the pieces to be grilled on the wire shelf or in the baking tray on the wire shelf so that the space covered does not exceed the size of the grill element. Slide the wire shelf or baking tray into the desired level of the oven. If you are grilling on the wire shelf, slide the baking tray to the lower rack to collect any fats. Add some water in the tray for easy cleaning.

 	Foods that are not suitable for grilling create a fire risk. Only grill food which is suitable for intensive grilling heat. Do not place the food too far in towards the back of the grill. This is the hottest area and fatty food may catch fire.
--	---

#### Rack positions (For models with wire shelf)

It is important to place the wire shelf onto the side rack correctly. Wire shelf must be inserted between the side racks as illustrated in the figure. Do not let the wire shelf stand against the rear wall of the oven. Slide your wire shelf to the front section of the rack and settle it with the help of the door in order to obtain a good grill performance.

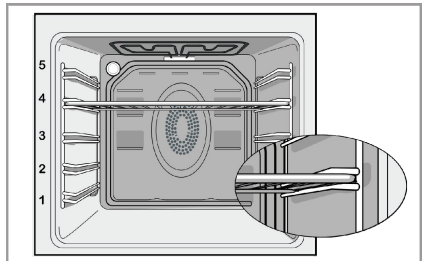

#### Tips for saving energy

The following information will help you to use your appliance in an ecological way, and to save energy:

- Use dark coloured or enamel coated cookware in the oven since the heat transmission will be better.
- While cooking your dishes, perform a preheating operation if it is advised in the user manual or cooking instructions.
- Do not open the door of the oven frequently during cooking.
- Try to cook more than one dish in the oven at the same time whenever possible. You can cook by placing two cooking vessels onto the wire shelf.
- Cook more than one dish one after another. The oven will already be hot.
- You can save energy by switching off your oven a few minutes before the end of the cooking time. Do not open the oven door.
- Defrost frozen dishes before cooking them.

## Using the meat probe

1. After setting your oven to a certain function and temperature, place the meat probe connection socket (2) into its slot (1) on the side wall of the chassis.

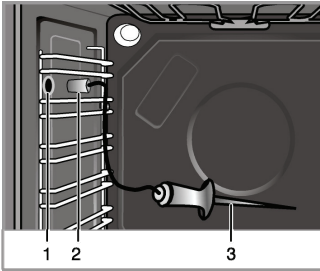

1. Meat probe slot.
2. Meat probe connection socket.
3. Meat probe sensor end.

i

Oven must be set to a certain function and temperature in order to allow the meat probe to operate.

Meat probe is active during the operation of functions where the meat probe symbol is displayed continuously.

If you have set the oven timer to a certain cooking time before using the meat probe, this time setting will be cancelled automatically when you attach the meat probe.

2. Stab the sensor end of your meat probe into the meat.

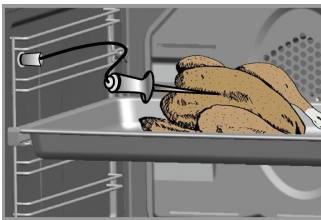

The oven detects the meat probe automatically when attached, P75 will appear on the temperature indicator field. The meat probe sensor automatically detects that the temperature inside the meat has reached the set temperature and then switches off the oven.

i

If P75 does not appear in the temperature indicator field, make sure that the connection socket has been securely seated into its slot.

- Recommended meat probe temperature is 75°C press + or - (7) to set the desired temperature between 40 and 99°C.

- If you remove the meat probe before cooking is complete, the oven continues to operate with the function and temperature you have previously set.
- Clean the meat probe with a damp cloth and dry with a dry cloth after each time you use it.

i

If you use the meat probe without stabbing the sensor end into the meat, the sensor end detects the temperature inside the oven and switches the oven off when the set temperature is attained. However, if the meat probe is subjected to temperatures at or above 250°C its sensor will be damaged irreparably.

Cooking level	Meat core temperature (°C)
Very rare	55-59
Rare	60-62
Medium rare	63-70
Medium	71-76
Well done	77-81
Very well done	≥82

\* For food safety it is recommended for the core (the coldest point) of meat (red meat and white meat) to reach minimum 72°C .

## How to operate the top oven

1. Set the Temperature knob to the desired temperature.
  2. Set the selector knob to the desired operating mode.
    - » Oven heats up to the adjusted temperature and maintains it. During heating, the temperature indicator light cycles.
- Switching off the electric oven**  
Turn the function knob and temperature knob to the off position.

Your oven is equipped with pop-out knobs that protrude when you press them.

1. Press inwards to protrude the knob and then turn it to make the desired setting .

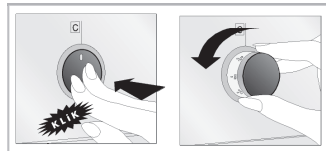

2. When the cooking process is finished, turn the knob to off (upper) position and press it inwards.

## Operating modes

The order of operating modes shown here may be different from the arrangement on your product.

### Slow cooking/Eco Fan Heating



To save power, you can use this function instead of the cooking operations that you would perform by using Fan Heating at 160-220°C temperature range. But, the cooking time will increase a little bit. Cooking times related to this function are indicated in 'Slow cooking/Eco Fan Heating' table .

### Top and bottom heating (Static)

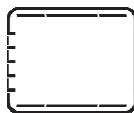

Food is heated simultaneously from the top and bottom. For example, it is suitable for cakes, pastries, or cakes and casseroles in baking moulds. Cook with one tray only.  
Suitable rack position will be displayed on screen.

### Fan supported bottom/top heating



Hot air heated by the bottom and top heaters is evenly distributed throughout the oven rapidly by means of the fan. Cook with one tray.

### Fan Heating



Warm air heated by the rear heater is evenly distributed throughout the oven rapidly by means of the fan. It is suitable for cooking your meals in different rack levels and preheating is not required in most cases. Suitable for cooking with multi trays.

### "3D" function



Top heating, bottom heating and fan assisted heating are in operation. Food is cooked evenly and quickly all around. Cook with one tray only.

### Pizza function

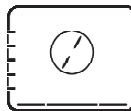

The bottom heating and fan assisted heating are in operation. Suitable for baking pizza.

### Full grill+Fan

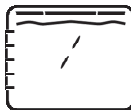

Hot air heated by the full grill is distributed very fast in the oven by means of the fan. It is suitable for grilling large amount of meat.  
Put big or medium-sized portions in correct rack position under the grill heater for grilling.  
Set the temperature to maximum level.  
Turn the food after half of the grilling time.

### Full grill



Large grill at the ceiling of the oven is in operation. It is suitable for grilling large amount of meat.  
Put big or medium-sized portions in correct rack position under the grill heater for grilling.  
Set the temperature to maximum level.  
Turn the food after half of the grilling time.



When the oven door is opened, the fan motor will not run in order to keep the hot air inside.



## Grill



Small grill at the ceiling of the oven is in operation. Suitable for grilling and gratin dishes. Put small or medium-sized portions in correct shelf position under the grill heater for grilling. Set the temperature to maximum level. Turn the food after half of the grilling time.

## Bottom heating



Only bottom heating is in operation. It is suitable for pizza and for subsequent browning of food from the bottom.

## Keep warm

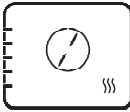

Used for keeping food at a temperature ready for serving for a long period of time.

## Operating with fan



The oven is not heated. Only the fan (in the rear wall) is in operation. Suitable for thawing frozen granular food slowly at room temperature and cooling down the cooked food.

## How to operate the oven control unit

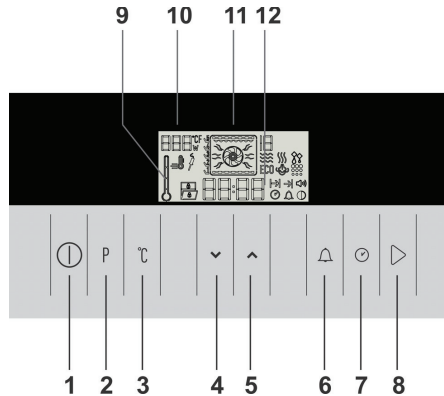

- 1 ON/OFF key
  - 2 Return key to function display
  - 3 Temperature setting key
  - 4 Minus key
  - 5 Plus key
  - 6 Alarm key
  - 7 Adjustment key
  - 8 Start/stop cooking key
  - 9 Oven inner temperature symbol
  - 10 Temperature indicator field
  - 11 Function display
  - 12 Current time indicator field
- 
- Cooking Time symbol
  - End of Cooking Time symbol
  - Function number
  - Alarm symbol
  - Clock symbol
  - Keylock symbol
  - Open door symbol
  - Booster symbol (rapid pre-heating)
  - Meat Probe symbol
  - Cooking pause symbol
  - Cooking starting symbol

### Function table:

Function table indicates the operating functions that can be used in the oven and their respective maximum and minimum temperatures.

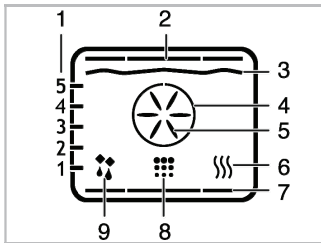

- 1 Shelf positions
- 2 Top heater
- 3 Grill heater
- 4 Boost heater
- 5 Boost fan
- 6 Keep warm
- 7 Bottom heater
- 8 Cleaning position
- 9 Operating with fan position

 Functions vary depending on the product model!

Function table	Recommended temperature (°C)	Temperature range (°C)
Eco Fan Heating	180	160-220
Top and bottom heating	200	40-280
Fan supported bottom/top heating	175	40-280
Fan heating	180	40-280
"3D" function	205	40-280
Pizza function	210	40-280
Full grill + fan	200	40-280
Full grill	280	40-280
Low grill	280	40-280
Bottom heating	180	40-220
Keep warm	60	40-100
Operating with fan	60	40-100

 Maximum adjustable cooking time in modes except warm keeping is limited with 6 hours due to safety reasons. Program will be cancelled in case of power failure. You must reprogram the oven.

While making any adjustment, related symbols on the clock will flash

Current time cannot be set while the oven is operating in any function, or if semi-automatic or full automatic programming is made on the oven.

Even if the oven is off, oven lamp lights up when the oven door is opened.











### How to operate the oven

1. Touch the  key for approx. 2 seconds to open the oven.
- » First operating function appears on display after the oven turns on. When the display is in this mode, cooking time, the end of cooking time and Booster (quick heating) function can be set.

 Oven will switch off automatically within 20 seconds if no oven setting is made on this screen.

### Manual cooking by selecting temperature and operating function

You can do cooking by selecting temperature and operating function specific to your meal, manually controlling without setting the cooking duration.

1. First operating function appears on display after touching  button to open the oven.
2. Select the operating function by touching the  /  keys.
3. If you desire to change the temperature that is recommended for operating function, enable the temperature field by touching  button.
- »  symbol flashes.
4. Set the desired temperature touching  /  keys.
5. Confirm the temperature setting by touching  key.
6. Put your dish into the oven.
7. Touch  key to start cooking if temperature and operating function are appropriate.  symbol appears on display.

» Your oven will readily start operating in the selected function and will increase the inner temperature to the set temperature. Each grades of the inner temperature symbol will be lit as inner temperature reaches to the set temperature. Additional active heaters and recommended tray position appear in the Function display.

8. The oven does not turn off automatically due to the manual cooking without setting the cooking time.

You can finish cooking by touching  key once again.



» The oven finishes the cooking and  symbol appears on display.

9. Touch the  button for approx. 2 seconds to close the oven.

#### **Cooking by setting the cooking time;**



You can ensure that the oven turns off by selecting temperature and operating function specific to your meal and setting the cooking time, manually controlling without setting the cooking duration.

1. First operating function appears on display after touching  button to switch on the oven.



2. Select the operating function by touching the  /  keys.



3. If you desire to change the temperature that is recommended for operating function, enable the temperature field by touching  button.

»  symbol flashes.

4. Set the desired temperature touching  /  keys.

5. Confirm the temperature setting by touching  key.

6. Touch  until  symbol appears on display for cooking time.

7. Set the cooking time by touching  /  keys and confirm the setting by touching  key.

» Once the Cooking Time is set,  symbol will appear on display continuously.

8. Put your dish into the oven.

9. Touch  key to start cooking if temperature, operating function and cooking time are

appropriate.  symbol appears on display.

» The oven will be heated up to the set temperature and will maintain this temperature until the end of the cooking time you selected.

» Your oven will readily start operating in the selected function and will increase the inner temperature to the set temperature. It maintains this temperature until the end of the set cooking time. Each grades of the inner temperature symbol will be lit as inner temperature reaches to the set temperature. Additional active heaters and recommended tray position appear in the Function display.

10. After the cooking process is completed, "End" appears on the display and the alarm sounds.



11. Touch any key to silence the alarm.

» Alarm stops and the oven finishes operating automatically.

#### **Setting the end of cooking time to a later time;**



**You can ensure that the oven runs and turns off automatically by setting temperature and operating function specific to your meal, the cooking time and end of cooking to a later time, manually controlling without setting the cooking duration.**

1. First operating function appears on display after touching  button to open the oven.



2. Select the operating function by touching the  /  keys.



3. If you desire to change the temperature that is recommended for operating function, enable the temperature field by touching  button.

»  symbol flashes.



4. Set the desired temperature touching  /  keys.



5. Confirm the temperature setting by touching  key.

6. Touch  until  symbol appears on display for cooking time.

7. Set the cooking time by touching  /  keys and confirm the setting by touching  key.



» Once the Cooking Time is set,  symbol will appear on display continuously.

8. Touch  until  symbol appears on display for the end of cooking time.

9. Set the cooking time by touching  /  buttons and confirm the setting by touching  key.

» Once the the end of cooking time is set,  symbol will appear on display continuously.

10. Put your dish into the oven.

11. Touch  key to start cooking if temperature, operating function, cooking time and the end of cooking time are appropriate.  symbol appears on display.

» Oven timer automatically calculates the startup time for cooking by deducting the cooking time from the end of cooking time you have set. Selected operation mode is activated when the startup time of cooking has come and the oven is heated up to the set temperature. It maintains this temperature until the end of the set cooking time. Each grades of the inner temperature symbol will be lit as inner temperature reaches to the set temperature. Additional active heaters and recommended tray position appear in the Function display.

12. After the cooking process is completed, "End" appears on the display and the alarm sounds.
13. Touch any key to silence the alarm.
- » Alarm stops and the oven finishes operating automatically.



If you want to cancel only cooking time or cooking time plus the end of cooking time after you have set them, you need to reset the cooking time

### Setting the booster (Quick Pre-heating)

Use Booster (Rapid Pre-heating) function to make the oven reach the desired temperature faster.



Booster cannot be selected in defrosting, keeping warm and cleaning positions. Booster settings will be cancelled in case of power outage.

1. Touch key after setting the temperature, operating function, cooking time and the end of cooking time.
  - » symbol appears continuously and booster (rapid pre-heating) setting is enabled.
  - » Booster symbol disappears as soon as the oven reaches the desired temperature and oven resumes operating in the function it was in before the Booster function.
2. Touch the key again in order to cancel booster function.
  - » symbol disappears and booster (rapid pre-heating) setting is disabled.

### Switching off the electric oven

Touch key to switch off the oven.

### Activating the keylock

You can prevent oven from being intervened with by activating the key lock function.

1. Touch until symbol appears on display.
  - » "OFF" will appear on the display.
2. Press to activate the key lock.
  - » Once the key lock is activated, "On" appears on the display and the symbol remains lit. Confirm by touching .



Oven keys are not functional when the key lock is activated. Key lock will not be cancelled in case of power failure.

### To deactivate the keylock,

1. Touch until symbol appears on display.
    - » "On" will appear on the display.
  2. Disable the key lock by pressing the key.
    - » "OFF" will appear once the key lock is deactivated.
- Confirm by touching .



Oven keys are not functional when the Key lock function is activated. Key lock settings will not be cancelled in case of power outage.

### Setting the alarm clock

You can use the timer of the product for any warning or reminder apart from the cooking program. The alarm clock has no influence on the functions of the oven. It is only used as a warning. For example, this is useful when you want to turn food in the oven at a certain point of time. Timer will give an audio warning at the end of the set time.

1. Touch until symbol appears on display.



Maximum alarm time can be 23 hours and 59 minutes.

2. Set the alarm duration by using / keys.
  - » symbol will remain lit and the alarm time will appear on the display once the alarm time is set.
3. At the end of the alarm time, symbol starts flashing and the audio warning is heard.

### Turning off the alarm

1. Audio warning sounds for 2 minutes. To stop the audio warning, just press any key.
  - » Audio warning will be silenced and current time will be displayed.





### Cancelling the alarm

1. Touch until symbol appears on display in order to cancel the alarm.
2. Press and hold key until "00:00" is displayed.







Alarm time will be displayed. If the alarm time and cooking time are set concurrently, shortest time will be displayed.

### Changing the time of the day





1. Touch  key in short intervals until  symbol appears on display.
2. Touch  /  keys to set the hour.
3. Confirm the setting by touching  symbol and wait for 4 seconds without touching any keys to confirm.



	Current time settings are cancelled in case of power failure. It needs to be readjusted. Current time can not be changed when any of the oven functions is in use.
--	--

### Adjusting the volume



1. While the oven is in Standby mode, touch  key in short intervals until 'VOL' appears on display.
2. Press  /  keys to set one of L0, L1 or L2 tones.
3. Press  key or wait for 4 seconds without touching any keys to confirm the setting

### Adjusting the Eco lamp setting

1. While the oven is in Standby mode, touch  key in short intervals until 'LP' appears on display.
2. Press  /  keys to set On or ECO option.
3. Press  key or wait for 4 seconds without touching any keys to confirm the setting
4. When set to ON; while the oven door is open in Standby mode and during operation the lamp is turned ON continuously.
5. When set to ECO; while the oven door is open in Standby mode and during operation the lamp is turned ON and then turned OFF after 15 seconds.

If any key is touched during operation ( excluding  and  keys) the lamp is turned ON and then turned OFF after 15 seconds.

### Oven clock brightness settings procedure:

1. Switch DB power "ON" to oven. Clock lights up.
2. Press adjustment key  until the brightness symbol appears.
3. Press Plus Key  to select brightness level from 1 to 4 .
4. Wait 7 seconds until Brightness symbol disappears.
5. Brightness change is activated.

## Baking and roasting



1st rack of the oven is the bottom rack.  
Note: The higher top heat in the new oven will necessitate a lower shelf position.

## Cooking times table



The timings in the chart below are meant as a guide. Timings may vary due to temperature of food, thickness, type and your own preference of cooking.

## Rack positions

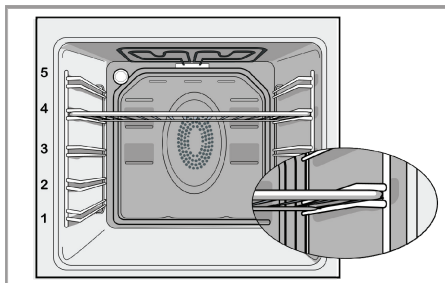

Suggested temperatures for Thermofan and Conventional ovens	THERMOFAN OVEN			CONVENTIONAL OVEN		
	TEMP °C	MINUTE	RACK POSITION	TEMP °C	MINUTE	RACK POSITION
<b>SPONGE CAKE</b> Egg and sugar creaming method	175°C - 180°C	20 - 25	3	190°C	20 - 25	2
<b>BUTTER CAKE</b> Margarine / butter and sugar creaming method	165°C	20 - 25	3	180°C	20 - 25	2
<b>LOAF CAKE</b> Date, Ginger and Banana Loaf	165°C	45	3	180°C	45	2
<b>PASTRIES</b>	200°C - 210°C	20	3	220°C	20	2
<b>SCONES</b>	200°C - 210°C	12 - 15	3	220°C	12 - 15	2
<b>PIES AND SAUSAGE ROLLS</b>	200°C - 210°C	25	3	220°C	25	2
<b>BISCUITS</b> Golden brown Sensitive biscuits	160°C 150°C	15 - 20	3	180°C	15 - 20	2
<b>SHORTBREAD</b> 15mm thick	140°C	60	3	150°C	60	2
<b>MERINGUES</b> <b>Important:</b> Leave meringues in oven until cold 'Sensitive'	120°C 110°C	75 90	3	135°C 120°C	75 90	2
<b>TARTS</b> Apple, Lemon Meringue, Milk	165°C	25 - 30	3	180°C	25 - 30	2
<b>CHEESECAKE</b> Temperatures and times may vary depending on the type of cheesecake being made. <b>Some require slower baking. NOTE:</b> Size and depth of the cheese filling will determine baking time.	165°C Bake 170°C Then 150°C	25 10 25 - 30	3	180°C Bake 180°C Then 160°C	25 10 25 - 30	2
<b>CHEESE CAKECRUST/PASTRY</b> The crust of the cheesecake will be better if pre-baked at..	170°C	10 - 12	3	180°C	10 - 12	2
<b>ROASTS Chicken, Beef, Mutton</b> The time will vary according to level of rareness desired	Bake 200°C Then 180°C	30 ± 90	3	Bake 200°C Then 180°C	30 ± 90	3
<b>BREAD</b> Using yeast	Bake 210°C Then 190°C	15 - 45	3	Bake 220°C Then 180°C	15 - 45	2
<b>FRUIT CAKE Rich Fruit Cake</b> The larger the tin, the longer the period. Temperatures and times given are for a square 8" (20cm) tin. <b>NOTE:</b> Lightly test the centre of the cake with a forefinger at 3½ - 4 hours baking time. This will ensure that the cake is not overdone. The centre of the cake must feel firm to the touch and leave no indentation.	Bake 130°C Then 120°C	60 - 180	3	Bake 145°C Then 135°C	60 - 180	2
<b>BOILED FRUIT CAKE</b> The larger the tin, the longer the period. Temperatures and times given are for a square 8" (20cm) tin.	150°C	120	3	160°C	120	2

When cooking with 2 trays at the same time, place the deeper tray on the upper rack and the other one on the lower rack.

\* It is suggested to perform preheating for all foods.

## Slow cooking/Eco Fan Heating

	Do not change the cooking temperature after cooking starts in Slow cooking/Eco Fan Heating mode.
	Do not open the door during cooking in the Slow cooking/Eco Fan Heating mode.

### Tips for baking cake

- If the cake is too dry, increase the temperature by 10°C and decrease the cooking time.
- If the cake is wet, use less liquid or lower the temperature by 10°C.
- If the cake is too dark on top, place it on a lower rack, lower the temperature and increase the cooking time.
- If cooked well on the inside but sticky on the outside use less liquid, lower the temperature and increase the cooking time.

### Tips for baking pastry

- If the pastry is too dry, increase the temperature by 10°C and decrease the cooking time. Dampen the layers of dough with a sauce composed of milk, oil, egg and yoghurt.
- If the pastry takes too long to bake, pay care that the thickness of the pastry you have prepared does not exceed the depth of the tray.
- If the upper side of the pastry gets browned, but the lower part is not cooked, make sure that the amount of sauce you have used for the pastry is not too much at the bottom of the pastry.

Try to scatter the sauce equally between the dough layers and on the top of pastry for an even browning.

	Cook the pastry in accordance with the mode and temperature given in the cooking table. If the bottom part is still not browned enough, place it on one lower rack next time.
--	---











### Tips for cooking vegetables



- If the vegetable dish runs out of juice and gets too dry, cook it in a pan with a lid instead of a tray. Closed vessels will preserve the juice of the dish.
- If a vegetable dish does not get cooked, boil the vegetables beforehand or prepare them like canned food and put in the oven.

## How to operate the grill

	<b>WARNING</b> Close oven door during grilling. Hot surfaces may cause burns!
--	---

### Switching on the grill

1. First operating function appears on display after touching  button to open the oven.
2. Touch  /  to select the desired grill function.
3. If you desire to change the temperature that is recommended for operating function, enable the temperature field by touching  button.  
»  symbol flashes.
4. Set the desired temperature touching  /  keys.
5. Confirm the temperature setting by touching  key.
6. Touch   key to start grilling if temperature and operating function are appropriate.  symbol appears on display.



	Foods that are not suitable for grilling create a fire risk. Only grill food which is suitable for intensive grilling heat. Do not place the food too far in the back of the grill. This is the hottest area and fatty food may catch fire.
	Do not use the top embossed runner for grilling.

## Cooking times table for grilling

### Grilling with electric grill

Food	Insertion level	Grilling time (approx.)
Fish	4...5	20...25 min. #
Sliced chicken	4...5	25...35 min.
Lamb chops	4...5	20...25 min.
Roast beef	4...5	25...30 min. #
Veal chops	4...5	25...30 min. #
Toast bread	4	1...2 min.
# depending on thickness		

» Your oven will readily start operating in the selected function and will increase the inner temperature to the set temperature. Each grades of the inner temperature symbol will be lit as inner temperature reaches to the set temperature. Additional active heaters and recommended tray position appear in the Function display.

7. You can finish grilling by touching   button once again.  
» The oven finishes grilling and  symbol appears on display.

### Switching off the grill

Touch the  button for approx. 2 seconds to switch off the oven.



## 5. Maintenance and care

### General information

- Clean the appliance thoroughly after each use, making it easier to remove cooking residues and helps prevent these from burning on the next use of the appliance.
- Wipe down the cabinet, door, control panel, trims and handles with a damp, hot soapy cloth.
- Use only liquid household cleaners and avoid abrasive powders, scouring pads and caustic cleaners.
- Rinse and wipe down with a clean cloth.

### Cleaning the oven

- Open the oven door and allow the oven to cool down.
- Clean the oven with a damp, hot soapy cloth. Do not use a steam cleaner.
- It may be necessary to soak burnt soils with a liquid cleaner to soften them before scrubbing them with a nylon brush or scouring sponge.
- Heavy soils on the bottom of the oven may require overnight soaking under a sponge liberally sprinkled with household ammonia. Remove the soil the following morning by washing normally.
- Always ensure that any excess liquid is thoroughly wiped off after cleaning and any spillage is immediately wiped dry.
- Do not use cleaning agents that contain acid or chloride to clean the stainless or inox surfaces and the handle. Use a soft cloth with a liquid detergent (not abrasive) to wipe these parts clean, paying attention to sweep in one direction.
- For your convenience, the shelves may be removed to improve access.

- To prevent the wire grill and tray inside the oven from damaging the oven door, place a strip of cardboard onto the inside of the oven door that lines up with the position of the trays. Tape the oven door to the side walls.
- Do not use the door or handle to lift or move the appliance.

### Removing the oven door

#### Lift-off oven door

The oven door may be removed to improve oven access during cleaning.

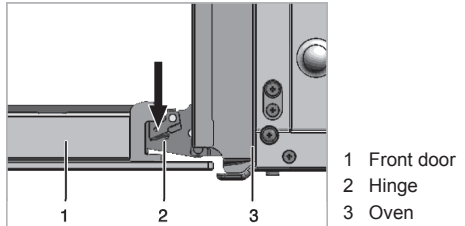

#### Removing the oven door

1. Open the front door (1).
2. Open the clips at the hinge housing (2) on the right and left hand sides of the front door by lifting them up. Hold the door on both sides and then close the door and lift the door up to remove it. Refitting is the reversal of removing.

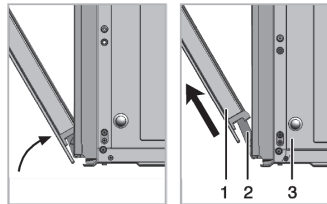

	<b>DANGER</b> Risk of electric shock! Switch off the electricity before cleaning the appliance to avoid an electric shock.
	<b>DANGER</b> Hot surfaces may cause burns! Allow the appliance to cool down before you clean it.
	The surface may get damaged by some detergents or cleaning materials. Do not use aggressive detergents, cleaning powder/cream or any sharp objects. Do not use any harsh abrasive cleaners or sharp metal scrapers to clean the oven door and glass since they can scratch the surface, destroy the glass and could result in the glass shattering.

	Steps carried out during the removal process should be carried out in reverse order to install the door. Do not forget to close the clips at the hinge housing when reinstalling the door.
--	--

#### Removing the door inner glass

The inner glass panel of the oven door can be removed for cleaning. Open the oven door.

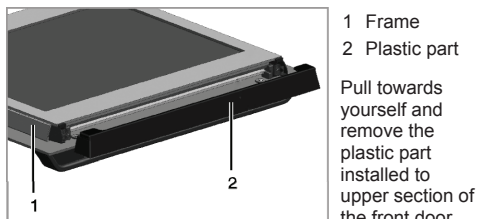

### Future Transportation

- Keep the appliances original carton and transport the appliance in it. Follow the instructions on the carton. If you do not have the original carton, pack the appliance in bubble wrap or thick cardboard and tape it securely.

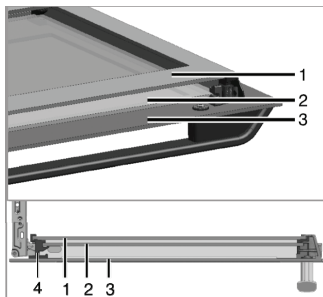

- 1 Innermost glass panel
- 2 Inner glass panel
- 3 Outer glass panel
- 4 Plastic glass panel slot-Lower

As illustrated in figure, raise the innermost glass panel (1) slightly in direction A and pull it out in direction B. Repeat the same procedure to remove the inner glass panel (2).

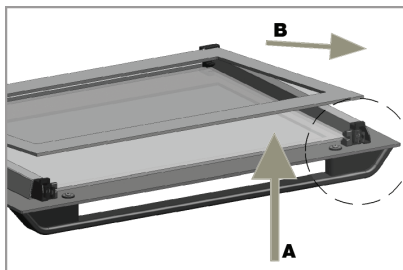

The first step to regroup the door is reinstalling inner glass panel (2). As illustrated in figure, place the chamfered corner of the glass panel so that it will rest in the chamfered corner of the plastic slot.



Inner glass panel (2) must be installed into the plastic slot close the innermost glass panel (1). When installing the innermost glass panel (1), make sure that the printed side of the panel faces towards the inner glass panel. It is important to seat lower corner of inner glass panel into the lower plastic slot. Push the plastic part towards the frame until you hear a "click".

### Removing the upper door inner glass

The entire inner glass panel of the upper oven door can be removed for cleaning.

1. Open the oven door.

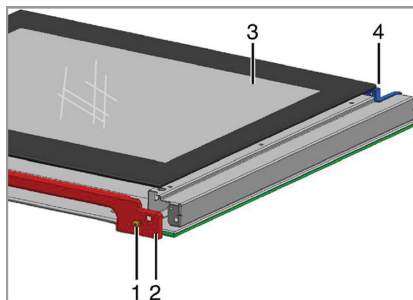

- 1 Screw
- 2 Profile
- 3 Inner glass pane
- 4 Plastic slot

2. Using a screwdriver remove both screws (1) at the top of the door profile (one on each side).
3. Remove the door profile and carefully take out the glass (3).
4. When refitting the glass ensure the bottom edge of the glass is securely placed in the plastic slots. Refit the door profile using the screws.

### Oven light

The oven light is switched on by the **multifunction selector** switch and switches off when the knob is returned to 0.

### Replacing the oven light bulb

	<p><b>DANGER:</b> Before replacing the oven lamp, ensure that the appliance is disconnected from mains and cooled down to avoid the risk of an electrical shock. Hot surfaces may cause burns!</p>
	<p>The oven lamp is a special electric light bulb that can resist up to 300°C. See Technical specifications for details. Oven lamps can be obtained from Authorised Service Agents.</p> <p>Position of lamp might vary from the figure.</p>

**If your oven is equipped with a round lamp:**

1. Disconnect the product from mains.
2. Turn the glass cover counter clockwise to remove it.

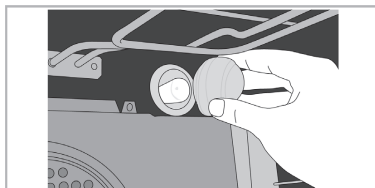

3. Remove the oven lamp by turning it counter clockwise and replace it with the new one.
4. Install the glass cover

**If your oven is equipped with a square lamp:**

1. Disconnect the product from mains.
2. Remove the wire racks as described. See Cleaning the oven.

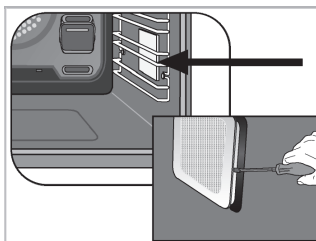

3. Remove the protective glass cover with a screwdriver.
4. Unscrew oven lamp and replace it with a new one.
5. Install the glass cover and then the wire racks.

**6. Troubleshooting**

<b><i>Oven emits steam when it is in use.</i></b>	
It is normal that steam escapes during operation	>>> This is not a fault.
<b><i>The appliance emits metal noises while heating and cooling.</i></b>	
When the metal parts are heated, they may expand and cause noise.	>>> This is not a fault.
<b><i>The appliance does not operate.</i></b>	
The mains distribution board has tripped.	>>> Check the mains distribution board for tripped circuit breakers.
The appliance is not plugged into the wall socket.	>>> Check the plug connection.
The wall switch is not on.	>>> Check the wall switch is on.
Buttons/knobs/keys on the control panel do not function.	>>> Keylock may be enabled. Please disable it. (See: Using the keylock)
<b><i>Oven light does not work.</i></b>	
Oven lamp is defective.	>>> Replace oven lamp.
Power is cut.	>>> Check if there is power. Check the fuses in the fuse box. If necessary, replace or reset the fuses.
<b><i>Oven does not heat.</i></b>	
Function and/or Temperature are not set	>>> Set the function and the temperature with the Function and/or Temperature knob/key.
Power is cut.	>>> Check if there is power. Check the fuses in the fuse box. If necessary, replace or reset the fuses.

**Owner's responsibility**

Since the following are not factory faults, they are the owner's responsibility.

- Damage to exterior finish.
- Breakage of glass and other components.
- Replacement of the light bulb.
- Damage through improper use or installation of the appliance.
- Damage caused by moving the appliance.

**7. Grundig Customer help-line**

If you have followed the instructions and still have a problem, contact the Grundig customer help line. They will be able to advise you on any aspect of the product or send a qualified technician to repair it.

**Note:** Before requesting service please check the trouble-shooting guide in the Operating Instructions as a charge may be levied where no fault is found even though your product may still be under guarantee.

Please contact the Grundig Customer help-line for service or any other queries on: **086 147 8634.**

## 8. Warranty

---

This certificate is issued by DEFY APPLIANCES (PTY) LIMITED manufacturers and suppliers of Grundig products, hereinafter the Company, to the original purchaser only, of the appliance described on the certificate and shall constitute the only warranty given in respect of this appliance.

The Company warrants to the original purchaser that for a period of FIVE YEARS from date of purchase the appliance is free from defect under normal domestic use, both in workmanship and material, subject to the following conditions.

1. Repair or replacement of any part of this appliance, found by the Company to be defective, shall be at the election of the Company. The Company reserves the right to effect such service through any of its Service Divisions or Authorised Service Dealers. The cost of such service shall be borne by the Company in full, provided that the appliance is located no further than 50km from a Company Service Centre or an Authorised Service Dealer. Where the appliance is located beyond the 50km radius, the purchaser shall be liable for the standard travelling charges, as determined by the Company.
2. Vitreous enamelware, fuses and lamps are specifically excluded from these warranties. It is an express condition of these warranties that the purchaser takes due care and attention in the use and maintenance of the appliance. Abuse, misuse in conflict with operating instructions, connection to incorrect voltages and subjection to commercial use shall release the Company from its obligations.
3. This warranty shall become void and cease to operate if the appliance is dismantled by, or any repairs to the appliance are effected by any persons not duly authorised by the Company, or if substitute parts not approved by the Company are used in the appliance, or if the serial number of the appliance is removed.
4. The Company shall not be responsible for damages resulting from fire, flood, civil disturbances or any Act of God. The Company shall not, in terms of these warranties be responsible nor held liable for any consequential loss or damage of any kind caused by or due to the failure or malfunction of the appliance. The Company shall not be responsible for damages caused by insect and/or animal infestation.
5. The Company shall not be responsible for transportation or other costs other than those incurred within the provisions of Point 1 of this Certificate.
6. **For warranties in the Republic of South Africa and Sub-Saharan Africa, please contact the Grundig customer help line listed on the previous page for service or any other queries.**
7. Where service is requested under warranty and no fault or defect can be found by the Company, all costs incurred will be for the purchaser's account.
8. This Certificate as well as your invoice will serve as proof of purchase. For the purpose of warranty, it will be essential to produce this Certificate and invoice. Failure to do so, will render the purchaser liable for service costs.

**KEEP THIS CERTIFICATE AND SALES INVOICE AS PROOF OF  
PURCHASE FOR WARRANTY PURPOSES.**