

# Quick Guide

## Operating the product

**!** Read "Safety Instructions" section first!

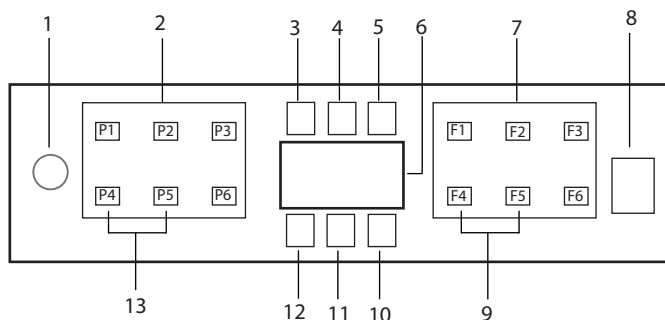

1. On / Off Button
2. Program Selection Button
3. Low Salt Warning Indicator
4. Low Rinse Aid Warning Indicator
5. Program Running Indicator
6. Display
7. Function Selection Button
  - F1 Hygiene Care function
  - F2 Automatic Liquid/Gel Detergent Dosage Function
  - F3 DeepClean function
  - F4 Delay function
  - F5 Express Function
  - F6 Remote Control (HomeWhiz) function
8. Start/Pause/Cancel Button
9. Doormatic Function
10. Doormatic Indicator
11. HomeWhiz Indicator
12. Child (Key) Lock Indicator
13. Child (Key) Lock Function

**i** Do not touch the machine display with wet hands.

**i** The buttons cannot be operated when the door is open. Make sure the door is closed for the buttons to operate.

**Programme Data and Average Consumption Values Table**

Programme number	1	2	3	4	5	6
<b>Programme name</b>	Auto	Intensive	Eco ***	QuickWash	Mini	Downloaded Program
<b>Cleaning temperature</b>	40 °C-65 °C	70 °C	50 °C	60 °C	35 °C	-
<b>Degree of Soiling</b>	It determines the soiling degree of the dishes and sets the temperature and amount of the washing water as well as the washing time automatically. It is suitable for all dish types.	It is suitable for heavily soiled pans and trays.	Suitable for washing dishes with normal amount of soil. It is the most efficient program in terms of combined power and water consumption. This is used for assessing the compliance with EU's eco-design directive.	It is the daily washing programme to wash the normally soiled left dishes in the fastest way.	It is suitable for quickly washing the lightly soiled dishes that have undergone precleaning process.	Please check the HomeWhiz app for programmes you can download through wireless connection.
<b>Prewash</b>	Medium to high	High	Medium	Medium	Low	-
<b>Wash</b>	+	+	+	-	-	-
<b>Dry</b>	+	+	+	+	+	-
<b>Duration (min)</b>	112-195	194	230	77	60	
<b>Water (l)</b>	9,4-12,4	16,8	9,5	10,6	10,8	
<b>Energy (kWh)</b>	0,90-1,45	1,51	0,84* / 0,861**	1,18	0,78	







\* : EN 60436:2016 \*\* : EN 60436:2020 The consumption values shown in the table were determined under standard conditions. Differences may therefore occur under practical conditions.  
 \*\*\* Reference programme for testing institutes. The tests in accordance with EN 50242/60436 must be carried out with a full water softener salt dispenser and a full rinse aid reservoir, and using the test programme. The values given for programmes other than Eco 50°C programme are indicative only.

# Quick Guide

## Adjusting the water softening system

Washing, rinsing and drying performance of your dishwasher will improve when the water softening system is adjusted correctly.







To adjust the system, first learn the water hardness in your region and adjust as indicated below.

- Unpack the test strip.
  - Open the tap and let the water flow for approx. 1 minute.
  - Dip in the test strip into the water for 1 second.
  - Take out the strip from the water and shake it.
  - Wait for 1 minute.
  - Make the necessary adjustment according to the test strip.
- |         |  |
|---------|--|
| Level 0 |  |
| Level 1 |  |
| Level 2 |  |
| Level 3 |  |
| Level 4 |  |
| Level 5 |  |

### After the determination of the water hardness:

1. When the door is closed, after turning on your machine with the On/Off button, enter the Sub-Menu by pressing the On-Off and P2 program buttons simultaneously for 3 seconds.
2. Move to "r" position on the display by pressing the P2 button.
3. Set it to the appropriate level by selecting one of the "r: 1", "r: 2", "r: 3", "r: 4" or "r: 5" positions with the P3 program button.
4. Exit the settings menu by pressing the On/Off button for 3 seconds. Your settings will be saved automatically.

### Water hardness level adjustment table

Hardness Level	English Water Hardness °dE	German Water Hardness °dH	French* Water Hardness °dF	Water Hardness Level Indicator
Level 0 	0-5	0-4	0-8	Press the Selection key to switch the water hardness level to position 1. (r1)
Level 1 	6-9	5-7	9-13	
Level 2 	10-15	8-12	14-22	Press the Selection key to switch the water hardness level to position 2. (r2)
Level 3 	16-19	13-15	23-27	Press the Selection key to switch the water hardness level to position 3. (r3)
Level 4 	20-24	16-19	28-34	Press the Selection key to switch the water hardness level to position 4. (r4)
Level 5 	25-62	20-50	35-90	Press the Selection key to switch the water hardness level to position 5. (r5)

- If the hardness level of the water that you use is above 50°dH or if you are using well water, than it is recommended to use filter and water purification devices.
  - Since your machine has an Automatic Water Hardness Detection System, you need to add salt suitable for the dishwasher when the Salt Indicator light turns on.If you do not add salt, the Automatic Water Hardness Detection System will not function correctly.
- i** Even though your machine is equipped with Automatic Water Hardness Detection System, water hardness setting is done by the authorised service agent/user during the first setup. When moving, your dishwasher will set the water hardness automatically, depending on the water hardness level of the place you have moved to.